











Prese ad Innesto Rapido - Quick Couplings - Schnellverschluss Kupplungen - Coupleurs Automatiques - Enchufes Rápidos - Conexões de Engate Rápido

<p>SERIE UNI ISO 6150 A-6</p>  <p>Serie 100 Pag. 15.7 - 15.10</p>	<p>SERIE MIGNON New</p>  <p>Serie 110 Pag. 15.11 - 15.16</p>	<p>SERIE UNI ISO 6150 B-12</p>  <p>Serie 120 Pag. 15.17 - 15.22</p>	<p>ITALIAN PROFILE</p>  <p>Serie 120 Pag. 15.23 - 15.28</p>
<p>SERIE UNI ISO 6150 B-15</p>  <p>Serie 130 Pag. 15.29 - 15.33</p>	<p>SERIE UNI ISO 6150 C-10</p>  <p>Serie 140 Pag. 15.34 - 15.39</p>	<p>EUROPEAN PROFILE</p>  <p>Serie 160 Pag. 15.40 - 15.45</p>	<p>SWISS PROFILE</p>  <p>Serie 170 Pag. 15.46 - 15.50</p>
<p>MIGNON PROFILE New</p>  <p>Serie 180 Pag. 15.51 - 15.54</p>	<p>MULTISOCKET New</p>  <p>Serie 190 - 63190 Pag. 15.55 - 15.61</p>	<p>JAPANESE PROFILE</p>  <p>Serie 400 Pag. 15.62 - 15.64</p>	<p>Serie 700 Pag. 15.65 - 15.67</p>
<p>SERIE UNI ISO 6150 B-17</p>  <p>Serie 710 Pag. 15.68 - 15.70</p>	<p>B-SOCKET EUROPEAN</p>  <p>Serie 720 Pag. 15.71 - 15.74</p>	<p>EUROPEAN PROFILE New</p>  <p>Serie 730 Pag. 15.75 - 15.80</p>	<p>EUROPEAN PROFILE New</p>  <p>Serie 740 Pag. 15.81 - 15.83</p>

Prese di Sicurezza ad Innesto Rapido - Safety Quick Couplings - Kupplungen Sicherheit - Coupleurs de Sécurité - Enchufes de Seguridad - Conexões de Segurança

<p>SERIE UNI ISO 6150 B-12</p>  <p>Serie 620 Pag. 15.85 - 15.88</p>	<p>ITALIAN PROFILE</p>  <p>Serie 650 Pag. 15.89 - 15.90</p>	<p>EUROPEAN PROFILE</p>  <p>Serie 660 Pag. 15.91 - 15.92</p>	<p>SWISS PROFILE</p>  <p>Serie 670 Pag. 15.93 - 15.94</p>
<p>SERIE UNI ISO 6150 B-12</p>  <p>Serie 0B120 Pag. 15.97 - 15.99</p>	<p>SERIE UNI ISO 6150 C-10</p>  <p>Serie 0B140 Pag. 15.100 - 15.102</p>	<p>EUROPEAN PROFILE New</p>  <p>Serie 0B160 Pag. 15.103 - 15.105</p>	

Giunti ad Innesto Rapido per Raffreddamento Stampi - Quick Couplings for Molding Cooling - Schnellkupplungen für Spritzgussanwendungen - Coupleurs pour Moulés D'injection - Enchufes Rápidos para Refrigeración de Moldes - Conexões de Engate Rápido para Resfriamento de Moldes

<p>FRENCH PROFILE DN 8 - DN 12</p>  <p>Series 410 - 420 - 510 - 520 Pag. 15.104 - 15.110</p>	<p>INTERNATIONAL PROFILE DN 6 - DN 9</p>  <p>Series 430 - 440 - 530 - 540 Pag. 15.112 - 15.119</p>	<p>EUROPEAN PROFILE DN 6 - DN 9</p>  <p>Series 460 - 470 - 560 - 570 Pag. 15.120 - 15.127</p>	<p>6049 Pag. 15.128</p> 
--	--	--	--

Pistole di Soffiaggio - Blow Guns - Blaspistolen - Soufflettes - Pistolas Sopladoras - Pistola de Ar

 <p>Series 360 Pag. 15.130 - 15.132</p>	 <p>Series 300 Pag. 15.133 - 15.135</p>	 <p>Spare Parts Pag. 15.136</p>	 <p>Series 340 Pag. 15.137</p>
---	---	--	--

Aligned si riserva il diritto di variare modelli e ingombri senza preavviso - Aligned reserves the right to vary models and dimensions without notice - Aligned behält sich das Recht vor, Daten ohne Ankündigung zu ändern
 Aligned se reserva el derecho de modificar modelos y dimensiones sin previo aviso - Aligned se reserva o direito de alterar os modelos e dimensões sem prévio aviso

SERIE 720 B-SOCKET

EUROPEAN DN 10 / UNI ISO 6150 B-15



Un'unica presa per 2 tipi di innesti

IT

È un dato di fatto che sul mercato esistono vari profili di innesti ben distinti sia nella forma che nelle dimensioni e generalmente necessitano di essere assemblati con specifiche prese che di norma non sono intercambiabili fra di loro.

Per poter ovviare a questa incompatibilità AIGNEP propone alla sua clientela una soluzione pratica ed economica, un'unica presa da utilizzare con 2 differenti tipi di profili garantendo per tutti una perfetta tenuta.

One socket for 2 different plugs

GB

It is a matter of fact that on the market are available various types of plugs well distinguished whether on the shape or on the dimensions, usually they need to be assembled with specific sockets which normally are not interchangeable.

To get round to this incompatibility AIGNEP is proud to offer to its customers a practical and cost-effective solution, a unique socket to be used with 2 different types of plugs, ensuring a perfect tightening.

1 Kupplung Für 2 Typen Von Steckern

DE

Es ist eine Tatsache, dass die auf dem Markt verfügbaren Kupplungen und Stecker mit verschiedenen, nicht kompatiblen Profilen in Form und Größe geliefert werden, d.h. sie können nicht untereinander ausgetauscht montiert werden.

Um diese Austauschbarkeit zu ermöglichen, bietet AIGNEP seinen Kunden eine praktische und kostengünstige Lösung an, wo mit einer Kupplung 2 verschiedene Profile (Stecker) verwendet werden können und dennoch eine perfekte Abdichtung gewährleistet ist.

1 Corps Pour 2 Embouts

FR

Le marché met à disposition des utilisateurs des différents types de coupleurs qui varient selon les normes, la forme et les dimensions. Souvent il est nécessaire d'assembler plusieurs types de coupleurs qui ne sont pas interchangeables.

Pour contourner cette incompatibilité AIGNEP est fière d'offrir à ses clients une solution pratique, fiable et rentable où un corps unique pour être utilisé avec 2 embouts différents.

Un único enchufe para 2 tipos de adaptador

ES

Es un dato a remarcar que en el mercado existen varios tipos de adaptadores distintos, ya sea en la forma como en las dimensiones, que generalmente necesitan de enchufes específicos no intercambiables entre ellos.

Para solucionar este problema AIGNEP, propone una solución práctica y económica de intercambiabilidad con todos los adaptadores homologados en el mercado europeo, garantizando para todos una perfecta estanqueidad.

Um único soquete p/ 2 tipos de plugs

PT

É um fato que no mercado existem vários perfis de plug bem diferentes entre si, seja no seu formato ou com relação às suas medidas e que, por isto normalmente não são intercambiáveis, necessitando de um soquete específico para cada diferente tipo de plug.

Para fugir desta incompatibilidade de tipos de modelos a AIGNEP propõe a seus clientes uma solução prática e econômica: um único soquete para ser utilizado com 2 diferentes tipos de perfis, garantindo para todos uma vedação perfeita.



CARATTERISTICHE TECNICHE
 TECHNICAL CHARACTERISTICS
 TECHNISCHE ANGABEN
 CARACTÉRISTIQUES TECHNIQUES
 CARACTERÍSTICAS TÉCNICAS
 CARACTERÍSTICAS TÉCNICAS



Norma di Riferimento
 Reference standard
 Entspricht der Norm
 Norme de référence
 Normativa de referencia
 Norma de referència

1907/2006
 REACH ✓

2011/65/CE
 RoHS ✓

PED
 2014/68/UE

SILICON
 FREE

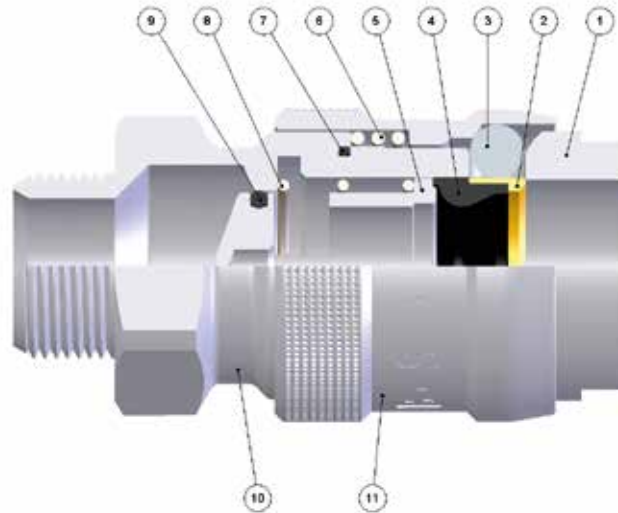

FKM A RICHIESTA
 IF REQUESTED FKM
 FKM AUF ANFRAGE
 FKM SUR DEMANDE
 FKM BAJO DEMANDA
 FKM SOB ENCOMENDA

UNI ISO 6150 B-15

EUROPEAN DN 10

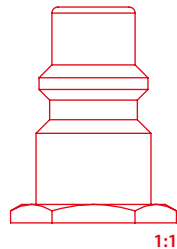

1:1

DN
 9 mm

Pag. 15.29

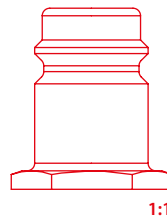

1:1

DN
 10 mm

Pag. 15.71

Materiali e Componenti

IT

- 1 Corpo in Ottone Nichelato
- 2 Anello Guida Innesto in Ottone Giallo
- 3 Sfera in Acciaio AISI 420
- 4 Guarnizione Sagomata Innesto in NBR
- 5 Otturatore in Ottone Nichelato
- 6 Molla Ghiera in Acciaio AISI 302
- 7 Guarnizione O-Ring in NBR
- 8 Molla Otturatore in Acciaio AISI 302
- 9 Guarnizione O-Ring in NBR
- 10 Attacco Terminale in Ottone Nichelato
- 11 Ghiera in Ottone Nichelato

Component Parts and Materials

GB

- 1 Nickel-Plated Brass Body
- 2 Yellow Brass Guide Ring Coupling
- 3 Stainless Steel AISI 420 Balls
- 4 NBR Plug Molded Seals
- 5 Nickel-Plated Brass Shutter
- 6 Stainless Steel AISI 302 Ring Nut Spring
- 7 NBR O-Ring Seals
- 8 Stainless Steel AISI 302 Shutter Spring
- 9 NBR O-Ring Seals
- 10 Nickel-Plated Brass Coupling Back Part
- 11 Nickel-Plated Brass Sleeve

Komponenten und Materialien

DE

- 1 Körper Messing Vernickelt
- 2 Hülse Messing
- 3 Kugel Edelstahl AISI 420
- 4 Dichtung NBR
- 5 Verschluss Messing Vernickelt
- 6 Entriegelungsfeder Edelstahl AISI 302
- 7 O-Ring NBR
- 8 Verschlussfeder Edelstahl AISI 302
- 9 O-Ring NBR
- 10 Einschraubkörper Messing Vernickelt
- 11 Entriegelungshülse Messing Vernickelt

Matériaux et Composants

FR

- 1 Corps: Laiton Nickelé
- 2 Bague: Laiton
- 3 Bille: Acier Inoxydable AISI 420
- 4 Joint En NBR
- 5 Clapet En Laiton Nickelé
- 6 Ressort De Bague: Acier Inoxydable AISI 302
- 7 Joint Torique En NBR
- 8 Ressort De Clapet: Acier Inoxydable AISI 302
- 9 Joint Torique En NBR
- 10 Corps: Laiton Nickelé
- 11 Bague: Laiton Nickelé

Materiales y Componentes

ES

- 1 Cuerpo en latón niquelado
- 2 Anillo en latón
- 3 Esfera en acero AISI 420
- 4 Junta en NBR
- 5 Obturador en latón niquelado
- 6 Muelle tuerca en acero AISI 302
- 7 Junta tórica en NBR
- 8 Muelle obturador en acero AISI 302
- 9 Junta tórica en NBR
- 10 Conexión terminal en latón niquelado
- 11 Tuerca en latón niquelado

Materiais e Componentes

PT

- 1 Corpo em latão niquelado
- 2 Anel em latão
- 3 Esfera em aço AISI 420
- 4 Vedação em NBR
- 5 Obturador em latão niquelado
- 6 Mola de porca em aço AISI 302
- 7 Vedação O-Ring em NBR
- 8 Mola do obturador em aço AISI 302
- 9 Vedação O-Ring em NBR
- 10 Conexão terminal em latão niquelado
- 11 Porca em latão niquelado



Pressione d'esercizio

Working Pressures

Betriebsdruck

Pression de service

Presión de Ejercicio

Pressão de Trabalho

0 bar

16 bar



Max pressione statica (no pulsazioni)

Maximum static pressure (no pulsations)

Maximaler statischer Betriebsdruck (ohne pulsations)

Pression statique maximale (sans pulsation)

Presión estática máxima (sin pulsaciones)

Pressão estática máxima (sem pulsações)

35 bar



Temperature

Temperatures

Temperatur

Températures

Temperaturas

Temperaturas

- 20 °C

+ 80 °C

Con O-ring in FKM

With FKM O-ring

Mit O-ring in FKM

Avec joints en FKM

Con junta tórica en FKM

Com O-ring em FKM

- 10 °C

+ 200 °C



Fluidi compatibili

Aria compressa

Fluids

Compressed air

Geeignete Medien

Druckluft

Fluides compatibles

Air comprimé

Fluidos compatibles

Aire comprimido

Fluidos compatíveis

Ar comprimido

Per altri fluidi, consultare l'ufficio tecnico Aignep.

For other fluids, consult the technical department Aignep.

Für andere Flüssigkeiten, kontaktieren Sie uns.

Pour d'autres fluides, veuillez nous consulter.

Para otros fluidos póngase en contacto con el departamento técnico Aignep.

Para outros fluidos consulte o departamento técnico da Aignep.



Portata

NI/min

Flow Rate

Durchflusswerte

Débit

Caudal de Flujo

Vazão

DN	6 bar Δ 1	6 bar Δ 0.5	6 bar *
9	3150	2500	3650
10	3300	2600	3800

* Scarico libero - Exhaust Free - Kostenlose Auspuff - Échappement libre - Escape Libre - Descarga livre.



Filettatura

IT

Threads

GB

Gewindearten

DE

Gas cilindrica conforme ISO 228 Classe A.

Parallel gas in conformity with ISO 228 Class A.

Zylindrisches Gewinde nach Norm ISO 228 Classe A.

Filetages

FR

Roscas

ES

Roscas

PT

Filetage cylindrique conforme: ISO 228 Class A.

Gas cilindrica conforme ISO 228 Clase A.

Gas paralela conforme ISO 228 Classe A.

721

PRESA MASCHIO

MALE SOCKET
 VERSCHLUSS-KUPPLUNG MIT AUSSENGEWINDE
 COUPLEUR MÂLE
 ENCHUFE MACHO
 SOQUETE COM ROSCA MACHO

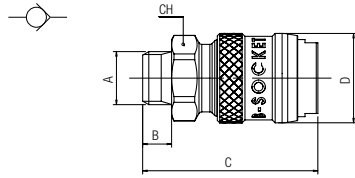

Code	A	B	C	D	CH	Pack.
00721 00 002	3/8	9	54.5	28	24	10
00721 00 003	1/2	10	55.5	28	24	10

722

PRESA FEMMINA

FEMALE SOCKET
 VERSCHLUSS-KUPPLUNG MIT INNENGEWINDE
 COUPLEUR FEMELLE
 ENCHUFE HEMBRA
 SOQUETE COM ROSCA FÊMEA

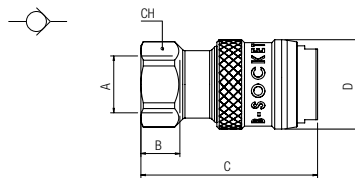

Code	A	B	C	D	CH	Pack.
00722 00 002	3/8	11.5	55	28	24	10
00722 00 003	1/2	12	56.5	28	24	10

821

INNESTO MASCHIO

MALE PLUG
 STECKER MIT AUSSENGEWINDE
 EMBOUT MÂLE
 ADAPTADOR MACHO
 PLUG COM ROSCA MACHO

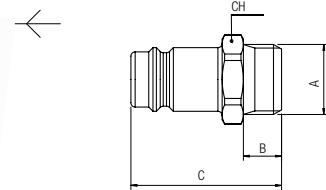

Code	A	B	C	CH	Pack.
00821 00 01 04 NB	3/8	9	35.5	19	10
00821 00 01 05 NB	1/2	10	37	24	10

822

INNESTO FEMMINA

FEMALE PLUG
 STECKER MIT INNENGEWINDE
 EMBOUT FEMELLE
 ADAPTADOR HEMBRA
 PLUG COM ROSCA FÊMEA

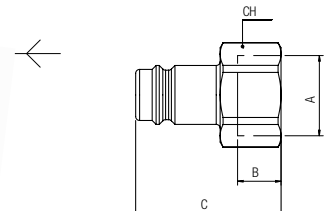

Code	A	B	C	CH	Pack.
00822 00 01 04 NB	3/8	11.5	34	19	10
00822 00 01 05 NB	1/2	14	37	24	10