





Prese ad Innesto Rapido - Quick Couplings - Schnellverschluss Kupplungen - Coupleurs Automatiques - Enchufes Rápidos - Conexões de Engate Rápido

<p>SERIE UNI ISO 6150 A-6</p>  <p>Serie 100 Pag. 15.7 - 15.10</p>	<p>SERIE MIGNON New</p>  <p>Serie 110 Pag. 15.11 - 15.16</p>	<p>SERIE UNI ISO 6150 B-12</p>  <p>Serie 120 Pag. 15.17 - 15.22</p>	<p>ITALIAN PROFILE</p>  <p>Serie 120 Pag. 15.23 - 15.28</p>
<p>SERIE UNI ISO 6150 B-15</p>  <p>Serie 130 Pag. 15.29 - 15.33</p>	<p>SERIE UNI ISO 6150 C-10</p>  <p>Serie 140 Pag. 15.34 - 15.39</p>	<p>EUROPEAN PROFILE</p>  <p>Serie 160 Pag. 15.40 - 15.45</p>	<p>SWISS PROFILE</p>  <p>Serie 170 Pag. 15.46 - 15.50</p>
<p>MIGNON PROFILE New</p>  <p>Serie 180 Pag. 15.51 - 15.54</p>	<p>MULTISOCKET New</p>  <p>Serie 190 - 63190 Pag. 15.55 - 15.61</p>	<p>JAPANESE PROFILE</p>  <p>Serie 400 Pag. 15.62 - 15.64</p>	<p>SERIE 700</p>  <p>Serie 700 Pag. 15.65 - 15.67</p>
<p>SERIE UNI ISO 6150 B-17</p>  <p>Serie 710 Pag. 15.68 - 15.70</p>	<p>B-SOCKET EUROPEAN</p>  <p>Serie 720 Pag. 15.71 - 15.74</p>	<p>EUROPEAN PROFILE New</p>  <p>Serie 730 Pag. 15.75 - 15.80</p>	<p>EUROPEAN PROFILE New</p>  <p>Serie 740 Pag. 15.81 - 15.83</p>

Prese di Sicurezza ad Innesto Rapido - Safety Quick Couplings - Kupplungen Sicherheit - Coupleurs de Sécurité - Enchufes de Seguridad - Conexões de Segurança

<p>SERIE UNI ISO 6150 B-12</p>  <p>Serie 620 Pag. 15.85 - 15.88</p>	<p>ITALIAN PROFILE</p>  <p>Serie 650 Pag. 15.89 - 15.90</p>	<p>EUROPEAN PROFILE</p>  <p>Serie 660 Pag. 15.91 - 15.92</p>	<p>SWISS PROFILE</p>  <p>Serie 670 Pag. 15.93 - 15.94</p>
<p>SERIE UNI ISO 6150 B-12</p>  <p>Serie 0B120 Pag. 15.97 - 15.99</p>	<p>SERIE UNI ISO 6150 C-10</p>  <p>Serie 0B140 Pag. 15.100 - 15.102</p>	<p>EUROPEAN PROFILE New</p>  <p>Serie 0B160 Pag. 15.103 - 15.105</p>	

Giunti ad Innesto Rapido per Raffreddamento Stampi - Quick Couplings for Molding Cooling - Schnellkupplungen für Spritzgussanwendungen - Coupleurs pour Moules D'injection - Enchufes Rápidos para Refrigeración de Moldes - Conexões de Engate Rápido para Resfriamento de Moldes

<p>FRENCH PROFILE DN 8 - DN 12</p>  <p>Series 410 - 420 - 510 - 520 Pag. 15.104 - 15.110</p>	<p>INTERNATIONAL PROFILE DN 6 - DN 9</p>  <p>Series 430 - 440 - 530 - 540 Pag. 15.112 - 15.119</p>	<p>EUROPEAN PROFILE DN 6 - DN 9</p>  <p>Series 460 - 470 - 560 - 570 Pag. 15.120 - 15.127</p>	<p>6049</p>  <p>Pag. 15.128</p>
---	---	---	---

Pistole di Soffiaggio - Blow Guns - Blasipistolen - Soufflettes - Pistolas Sopladoras - Pistola de Ar

<p>Series 360</p>  <p>Pag. 15.130 - 15.132</p>	<p>Series 300</p>  <p>Pag. 15.133 - 15.135</p>	<p>Spare Parts</p>  <p>Pag. 15.136</p>	<p>Series 340</p>  <p>Pag. 15.137</p>
--	--	---	---

Alignep si riserva il diritto di variare modelli e ingombri senza preavviso - Alignep reserves the right to vary models and dimensions without notice - Alignep behält sich das Recht vor, Daten ohne Ankündigung zu ändern
 Alignep se reserva el derecho de modificar modelos y dimensiones sin previo aviso - Alignep se reserva o direito de alterar os modelos e dimensões sem prévio aviso

ONE TOUCH

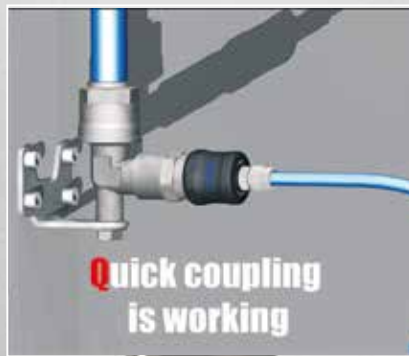

Serie 600 - Safety Quick Couplings



CARATTERISTICHE TECNICHE
 TECHNICAL CHARACTERISTICS
 TECHNISCHE ANGABEN
 CARACTÉRISTIQUES TECHNIQUES
 CARACTERÍSTICAS TÉCNICAS
 CARACTERÍSTICAS TÉCNICAS



Norma di Riferimento
 Reference standard
 Entspricht der Norm
 Norme de référence
 Normativa de referencia
 Norma de referència

1907/2006 REACH ✓	2011/65/CE RoHS ✓
PED 2014/68/UE	SILICON FREE
ISO 4414	

CONSIGLIATA CON INNESTI ACCIAIO
 ADVISE WITH STEEL PLUG
 EMPFOHLENE STECKER AUS STAHL
 EMBOUT RECOMMANDÉE EN ACIER
 ACONSEJADOS CON ADAPT EN ACERO
 ACONSELHADA COM PLUG EM AÇO

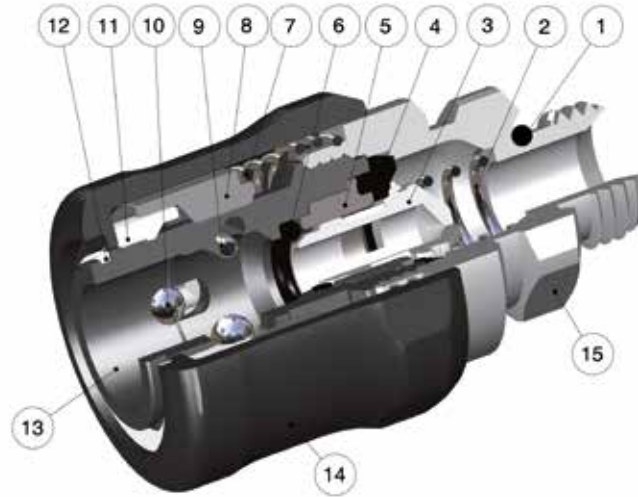

Materiali e Componenti	IT	Component Parts and Materials	GB	Komponenten und Materialien	DE
1 Guarnizione O-Ring in NBR 70		1 NBR 70 O-ring		1 O-Ring NBR 70	
2 Molla contrasto otturatore in acciaio INOX AISI 302		2 INOX steel AISI 302 shutter thrust spring		2 Verschlussfeder Edelstahl AISI 302	
3 Otturatore in ottone nichelato		3 Nickel-plated brass shutter		3 Verschluss Messing vernickelt	
4 Guarnizione in NBR 70		4 NBR 70 seal		4 Dichtung NBR 70	
5 Anello in ottone nichelato		5 Nickel-plated brass ring		5 Führungsring Messing vernickelt	
6 Guarnizione O-Ring in NBR 70		6 NBR 70 O-ring		6 O-Ring NBR 70	
7 Molla contrasto ghiera in acciaio INOX AISI 302		7 INOX steel AISI 302 ring nut thrust spring		7 Entriegelungsfeder Edelstahl AISI 302	
8 Anello trascinamento rullini in tecnopolimero		8 Technopolymeric trailing pins ring		8 Hinterer Führungsring Technopolymer	
9 Spina in acciaio INOX AISI 420		9 INOX steel AISI 420 pin		9 Stift Edelstahl AISI 420	
10 Sfera in acciaio INOX AISI 420		10 INOX steel AISI 420 ball		10 Kugel Edelstahl AISI 420	
11 Anello contenimento sfera in acciaio INOX AISI 303		11 INOX steel AISI 303 restraining balls ring		11 Kugel Führungsring Edelstahl AISI 303	
12 Seeger in acciaio INOX AISI 302		12 INOX steel AISI 302 seeger		12 Seegerring Edelstahl AISI 302	
13 Corpo in tecnopolimero		13 Technopolymeric Body		13 Körper Technopolymer	
14 Ghiera in tecnopolimero		14 Technopolymeric sleeve		14 Entriegelungshülse Technopolymer	
15 Attacco terminale in ottone nichelato		15 Nickel-plated brass coupling back part		15 Einschraubkörper Messing vernickelt	
Matériaux et Composants	FR	Materiales y Componentes	ES	Materialis e Componentes	PT
1 Joint torrique: NBR 70		1 Junta tórica en NBR 70		1 Vedação O-Ring em NBR 70	
2 Ressort de bague: acier inoxydable AISI 302		2 Muelle empuje obturador en acero INOX AISI 302		2 Mola do obturador em aço INOX AISI 302	
3 Clapet: laiton nickelé		3 Obturador en latón niquelado		3 Obturador em Latão em Latão Niquelado	
4 Joint: NBR 70		4 Junta en NBR 70		4 Vedação em NBR 70	
5 Bague de guidage: laiton nickelé		5 Anillo en latón niquelado		5 Anel em Latão Niquelado	
6 Joint torrique: NBR 70		6 Junta tórica en NBR 70		6 Vedação O-Ring em NBR 70	
7 Ressort: acier inoxydable AISI 302		7 Muelle empuje tuerca en acero INOX AISI 302		7 Mola da porca em aço INOX AISI 302	
8 Bague: technopolymère		8 Anillo deslizamiento perno en tecnopolímero		8 Anello trascinamento rullini in tecnopolimero	
9 Goupille: acier inoxydable AISI 420		9 Perno en acero INOX AISI 420		9 Pino em aço INOX AISI 420	
10 Bille: acier inoxydable AISI 420		10 Esfera en acero INOX AISI 420		10 Esfera em aço INOX AISI 420	
11 Cage à bille: acier inoxydable AISI 303		11 Anillo contención esfera en acero INOX AISI 303		11 Anel de contenção da esfera em aço INOX AISI 303	
12 Circlips: acier inoxydable AISI 302		12 Seeger en acero INOX AISI 302		12 Anel de retenção tipo Seeger em aço INOX AISI 302	
13 Corps: technopolymère		13 Cuerpo en tecnopolímero		13 Corpo em tecnopolímero	
14 Guidage: technopolymère		14 Tuerca en tecnopolímero		14 Porca em tecnopolímero	
15 Corps: laiton nickelé		15 Terminal en latón niquelado		15 Conexão terminal em Latão Niquelado	



Pressione d'esercizio

Working Pressures

Betriebsdruck

Pression de service

Presión de Ejercicio

Pressão de Trabalho

-0.99 bar (-0.099 MPa)

15 bar (1.5 MPa)



Temperature

Temperatures

Temperatur

Températures

Temperaturas

Temperaturas

- 20 °C

+ 80 °C



Fluidi compatibili

Aria compressa

Fluids

Compressed air

Geeignete Medien

Druckluft

Fluides compatibles

Air comprimé

Fluidos compatibles

Aire comprimido

Fluidos compatíveis

Ar comprimido



Portata

NI/min

Flow Rate

Durchflusswerte

Débit

Caudal de Flujo

Vazão

Innesto Plug Stecker Embout Adaptador Plug	6 bar Δ 1	6 bar Δ 0.5	6 bar *
220 AC	950	700	1400
250 AC	850	700	1170
260 AC	1300	1050	1830
270 AC	1000	750	1350

* Scarico libero - Exhaust Free - Kostenlose Auspuff - Échappement libre - Escape Libre - Descarga livre.



Filettatura

IT

Gas cilindrica conforme ISO 228 Classe A.

Threads

GB

Parallel gas in conformity with ISO 228 Class A.

Gewindearten

DE

Zylindrisches Gewinde nach Norm ISO 228 Classe A.

Filetages

FR

Filetage cylindrique conforme ISO 228 Class A.

Roscas

ES

Gas cilíndrica conforme ISO 228 Clase A.

Roscas

PT

Gas paralela conforme ISO 228 Classe A.

SERIE 620 UNI ISO 6150-B12

DN
5.5 mm

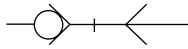

UNI ISO 6150-B12

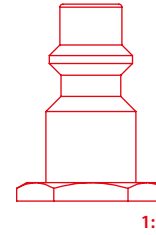

621

PRESA MASCHIO

MALE SOCKET

VERSCHLUSS-KUPPLUNG MIT AUSSENGEWINDE

COUPLEUR MÂLE

ENCHUFE MACHO

SOQUETE COM ROSCA MACHO

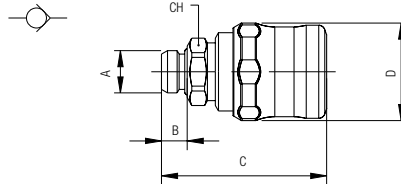

Code	A	B	C	D	CH	Pack.
00621 00 001	1/4	8	51.5	30.5	19	10
00621 00 002	3/8	9	52	30.5	20	10
00621 00 003	1/2	10	53	30.5	25	10

622

PRESA FEMMINA

FEMALE SOCKET

VERSCHLUSS-KUPPLUNG MIT INNENGEWINDE

COUPLEUR FEMELLE

ENCHUFE HEMBRA

SOQUETE COM ROSCA FÊMEA

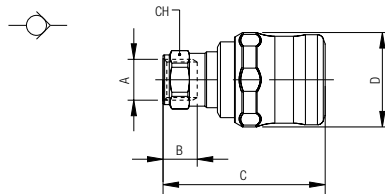

Code	A	B	C	D	CH	Pack.
00622 00 001	1/4	11	52	30.5	17	10
00622 00 002	3/8	12	53	30.5	20	10
00622 00 003	1/2	15	56	30.5	24	10

624

PRESA A CALZAMENTO

COMPRESSION SOCKET

VERSCHLUSS-KUPPLUNG MIT ÜBERWURFVERSCHRAUBUNG

COUPLEUR RACCORD À COIFFE

ENCHUFE TUBO

SOQUETE COM CONEXÃO PUSH-ON

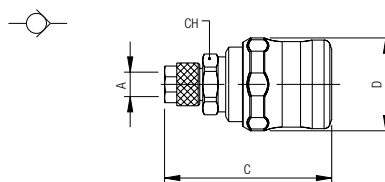

Code	A	C	D	CH	Pack.
00624 00 001	6/4	55	30.5	18	10
00624 00 002	8/6	54.5	30.5	18	10
00624 00 005	10/6.5	57.5	30.5	18	10
00624 00 003	10/8	56.5	30.5	18	10
00624 00 006	12/8	58	30.5	18	10
00624 00 004	12/10	57	30.5	18	10

625

PRESA CON PORTAGOMMA A RESCA

BARBED SOCKET

VERSCHLUSS-KUPPLUNG MIT SCHLAUCHTÜLLE

COUPLEUR À DOUILLE ANNELÉE POUR TUBE

ENCHUFE EPIGA

SOQUETE COM ESPIGÃO PARA MANGUEIRA DE BORRACHA

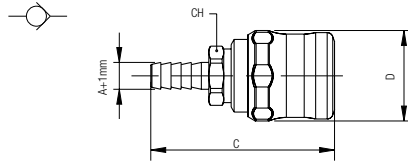

Code	A	C	D	CH	Pack.
00625 00 001	6	61.5	30.5	18	10
00625 00 002	8	61.5	30.5	18	10
00625 00 003	10	61.5	30.5	18	10
00625 00 004	12	61.5	30.5	18	10

221AC

INNESTO IN ACCIAIO MASCHIO

STEEL MALE PLUG

STECKER MIT AUSSENGEWINDE AUS STAHL

EMBOUT MÂLE EN ACIER

ADAPTADOR EN ACERO MACHO

PLUG EM AÇO COM ROSCA MACHO

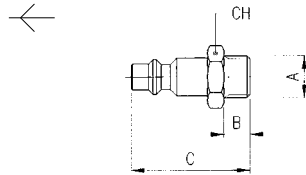

Code	A	B	C	CH	Pack.
221AC 00 51 03 ZI	1/4	8	36.5	17	10
221AC 00 51 04 ZI	3/8	9	37.5	19	10
221AC 00 51 05 ZI	1/2	10	39	24	10

Acciaio Indurito
Hardened Steel
Gehärtetem Stahl
Acier Trempé
Acero Curtido
Aço Endurecido

222AC

INNESTO IN ACCIAIO FEMMINA

STEEL FEMALE PLUG

STECKER MIT INNENGEWINDE AUS STAHL

EMBOUT FEMELLE EN ACIER

ADAPTADOR EN ACERO HEMBRA

PLUG EM AÇO COM ROSCA FÊMEA

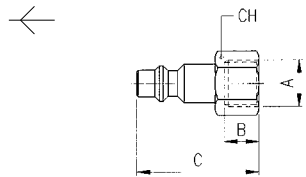

Code	A	B	C	CH	Pack.
222AC 00 51 03 ZI	1/4	11	36.5	17	10
222AC 00 51 04 ZI	3/8	11.5	37	19	10
222AC 00 51 05 ZI	1/2	15	40.5	24	10

Acciaio Indurito
Hardened Steel
Gehärtetem Stahl
Acier Trempé
Acero Curtido
Aço Endurecido

225AC

INNESTO IN ACCIAIO CON PORTAGOMMA A RESCA

STEEL BARBED PLUG

STECKER MIT SCHLAUCHTÜLLE AUS STAHL

EMBOUT À DOUILLE ANNELÉE POUR TUBE EN ACIER

ADAPTADOR EN ACERO EPIGA

PLUG EM AÇO COM ESPIGÃO PARA TUBO DE BORRACHA

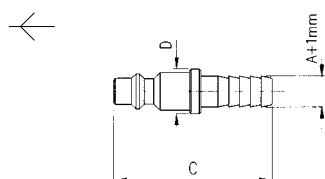

Code	A	C	D	Pack.
225AC 00 51 X4 ZI	6	43.5	12	10
225AC 00 51 X7 ZI	8	43.5	12	10
225AC 00 51 X9 ZI	10	46	14	10
225AC 00 51 Y1 ZI	12	46	16	10

Acciaio Indurito
Hardened Steel
Gehärtetem Stahl
Acier Trempé
Acero Curtido
Aço Endurecido