

Serie INOX

Raccordi automatici in acciaio INOX AISI 316 L

Stainless steel AISI 316 L push-in fittings
Steckverschraubungen aus edelstahl AISI 316 L
Raccords instantanés en acier inoxydable AISI 316 L
Racordaje automático en acero inoxidable AISI 316 L
Conexões push-in em aço inox AISI 316 L



New
Serie 60000

Pag. 6.4

Raccordi a calzamento in acciaio INOX AISI 316 L

Stainless steel AISI 316 L push-on fittings
Nippelverschraubungen aus edelstahl AISI 316 L
Raccords à coiffe en acier inoxydable AISI 316 L
Racordaje rápido en acero inox AISI 316 L
Conexões push-on em aço inox AISI 316 L



New
Serie 61000

Pag. 6.14

Adattatori in acciaio INOX AISI 316 L

Stainless steel AISI 316 L threaded adaptors
Adapter in edelstahl AISI 316 L
Adaptateurs en acier inoxydable AISI 316 L
Accesorios en acero inox AISI 316 L
Adaptadores em aço inoxidável AISI 316 L



New
Serie 62000

Pag. 6.22

Multipresa in acciaio INOX AISI 316 L

Stainless steel AISI 316 L multisocket
Kupplungen aus edelstahl AISI 316 L
Coupleurs multisocket en acier inoxydable AISI 316 L
Multipresa en acero inox AISI 316 L
Conexão multisocket em aço inox AISI 316 L



Serie 63000

Pag. 6.30

Raccordi a funzione in acciaio INOX AISI 316 L

Stainless steel AISI 316 L function fittings
Funktionsverschraubungen aus edelstahl AISI 316 L
Raccords à fonctions en acier inox AISI 316 L
Racordaje a funciones en acero inox AISI 316 L
Conexões funcionais em aço inoxidável AISI 316 L



New
Serie 66000

Pag. 6.34

Raccordi a compressione in acciaio INOX AISI 316 L

Stainless steel AISI 316 L compression fittings
Klemmringverschraubungen aus edelstahl AISI 316 L
Raccords à bagues biconne en acier inox AISI 316 L
Racordaje a compresión en acero inox AISI 316 L
Conexões de compressão em aço inoxidável AISI 316 L



New
Serie 69000

Pag. 6.38

Minivalvole a sfera in acciaio INOX AISI 316 L

Miniballvalve in stainless steel AISI 316 L
Kugelhähne AISI 316 L
Mini robinet a boisseau spherique en acier inoxydable AISI 316 L
Miniválvulas a esfera en acero inox AISI 316 L
Mini-válvulas de esfera em aço inoxidável AISI 316 L



Serie Ghinox

Pag. 6.46

Serie AUTOMATION INOX

Valvole Elettropneumatiche e Manuali

Solenoid Valve and Manual Valve
Elektropneumatische Ventile und Manuell
Distributeurs Electropneumatiques et Manuel
Válvulas Electroneumáticas y Manual
Válvulas Eletro-pneumáticas e Manual



Serie X1V

Pag. 17.13 - 17.47

Cilindri ISO 6432 e 15552

ISO 6432 and 15552 Cylinders
ISO 6432 und 15552 Zylinder
Vérins ISO 6432 et 15552
Cilindros ISO 6432 y 15552
Cilindros ISO 6432 e 15552



Serie MINI INOX, V and Accessories

Pag. 18.20 | 18.86 | 18.112

**RACCORDI AUTOMATICI, A CALZAMENTO, A COMPRESSIONE, INNESTI RAPIDI,
ADATTATORI, VALVOLE A SFERA, ELETTROVALVOLE E RACCORDI A FUNZIONE**

*PUSH-IN FITTINGS, PUSH-ON FITTINGS, COMPRESSION FITTINGS, QUICK COUPLINGS,
ADAPTERS, BALL VALVE, SOLENOID VALVES AND FUNCTION FITTINGS*

*STECKVERSCHRAUBUNGEN, ARMATUREN, VERSCHRAUBUNGEN, SCHNELLKUPPLUNGEN,
ADAPTER, MAGNETVENTILE, KUGELHÄHNE UND FUNKTIONSVERSCHRAUBUNGEN*

*RACCORDS INSTANTANÉS, À COIFFE, À BAGUES BICÔNE, COUPLEURS RAPIDES, ADAPTATEURS,
DISTRIBUTEURS, ROBINETS À BOISSEAU SPHÉRIQUE ET RACCORDS À FONCTIONS*

*RACORDAJE AUTOMÁTICO, RÁPIDO, A COMPRESIÓN, ENCHUFES RÁPIDOS,
ELECTROVALVULAS, ACCESORIOS, VÁLVULAS Y RACORES A FUNCIONES*

*CONEXÕES PUSH-IN, PUSH-ON, COMPRESSÃO, ENGATES RÁPIDOS, ACESSÓRIOS,
VÁLVULAS DE ESFERA, VÁLVULA SOLENÓIDE E CONEXÕES FUNCIONAIS*

Serie INOX

INOX



La serie 60000, istantanea, completamente in Acciaio Inox 316L, offre ai clienti Aignep la possibilità di veicolare fluidi corrosivi e/o creare circuiti in ambienti aggressivi.

Adatto al contatto permanente con fluidi alimentari, all'utilizzo in ambienti difficili, anche salini, possono essere sanificati e subire lavaggi anche con i detergenti più aggressivi.

Gamma certificata NSF 169 e conforme alle NSF 61 e NSF 372.

Principali vantaggi

- Connessione e sconnessione istantanea
- Pieno passaggio e tenuta al vuoto grazie a guarnizioni sagomate
- Tre tipologie di filettature, BSPP, BSPT e Metrica
- Completamente in Acciaio Inox 316L
- Permanenza fluidi alimentari
- Silicon Free

Applicazioni

- Automazione in presenza di lavaggi
- Industria Agroalimentare
- Industria Chimica, Petrochimica e Farmaceutica
- Medica, Life&Sciences
- Vuoto

La série 60000 est entièrement en acier inoxydable AISI 316L. Elle a été développée pour véhiculer des fluides corrosifs ou être utilisée dans des environnements agressifs.

Idéale pour les contacts avec les liquides alimentaires. Cette gamme peut être également utilisée en milieu salin et sur des machines qui ont besoin de lavages fréquents avec des détergents agressifs.

Série certifiée NFS 169 et conforme aux normes NSF 61 et NSF 372.

Principaux avantages

- Connexion et déconnexion instantanée.
- Plein débit et tenue au vide industriel grâce à des joints de forme
- 3 filetages disponibles, BSPP, BSPT (universel court) et Métrique
- Totalelement en acier inoxydable AISI 316L
- Compatible alimentaire et boissons
- Sans Silicone

Applications

- Automatisation avec lavage
- Industrie agroalimentaire
- Produits chimiques, Petro chimie, Pharmaceutique
- Médical
- Vide

The 60000 serie is fully made of stainless steel AISI 316L. It has been developed to drive corrosive fluids or to be used in aggressive environments. It is ideal for direct contact with food fluids.

This line can be used also in salty environment and on machines that need frequent washing with aggressive detergents.

Serie certified NSF 169 and conformed to NSF 61 & NSF 372 standards.

Main advantages

- Quick connection and disconnection
- Full Flow and Vacuum resistant tank to special shaped seals
- 3 threads available, BSPP, BSPT (universal short) & Metric
- Full stainless steel AISI 316L
- Food&Beverage compatible
- Silicon Free

Applications

- Automation with Washing
- Farming, Mining
- Chemical, Petrochemical, Pharmaceutical
- Medical, Life&Sciences
- Vacuum

Die 60000 Serie ist komplett aus Edelstahl AISI 316L. Sie wurde entwickelt für den Transport von korrosiven Medien oder zur Verwendung in aggressiven Umgebungen. Bestens geeignet für den direkten Kontakt mit flüssigen Lebensmitteln. Diese Serie kann auch in salzhaltiger Umgebung eingesetzt werden und auf Maschinen, die häufiges Waschen mit aggressiven Reinigungsmitteln benötigen.

Zertifiziert NSF 169 und konform zu den NSF 61 & NSF 372 Normen.

Hauptvorteile

- Schnelle Verbindung und Trennung
- Voller Durchfluss und Vakuumfestigkeit, dank spezieller Formdichtungen
- Drei Gewindearten, BSPP, BSPT (universal kurz) und metrisch
- Komplett aus Edelstahl AISI 316L
- Lebensmittel & Getränke konform
- Silikonfrei

Anwendungen

- Automation mit Waschen
- Landwirtschaft, Bergbau
- Chemie, Petrochemie, Pharma
- Medizin, Life Sciences
- Vakuum

La serie 60000, instantánea, completamente en acero inoxidable 316L, ofrece a los clientes Aignep la posibilidad de vehicular fluidos corrosivos y/o crear circuitos en ambientes agresivos.

Apto para el contacto permanente con fluidos alimentarios, para su uso en entornos difíciles, incluso salinos, pueden ser desinfectados y lavados incluso con los detergentes más agresivos.

Serie certificada NFS 169 y conforme con las normas NSF 61 y NSF 372.

Principales ventajas

- Conexión y desconexión instantánea
- Paso total y estanqueidad al vacío gracias a las juntas moldeadas
- Tres tipos de roscas, BSPP, BSPT y métrica
- Completamente en acero inoxidable 316L
- Compatible con fluidos alimentarios
- Libre de silicona

Aplicaciones

- Automatización en presencia de lavados
- Industria Agroalimentaria
- Industria Química, petroquímica y farmacéutica
- Medical, Life&Sciences
- Vacío

A série 60000 é totalmente fabricada em aço-inoxidável AISI 316L. Esta linha foi desenvolvida para conduzir fluidos corrosivos or para ser utilizada em ambientes agressivos. Ela é ideal para contato direto com fluidos alimnetícios.

Esta série pode ser utilizada também em ambientes com forte presença de sal e em máquinas que necessitam ser lavadas com frequência com detergentes agressivos.

Série certificados NFS 169 em conforme padres NSF 61 & NSF 372.

Principais vantagens

- Rápida conexão e desconexão
- Vazão Total e resistência ao Vácuo graças ao design de suas vedações
- 3 tipos de rosca disponíveis BSPP, BSPT (universal short) & Métrica
- Totalmente fabricada em aço-inoxidável AISI 316L
- Compatível com Alimentos e Bebidas
- Livre de Silicone

Aplicação

- Automação com lavagens frequentes
- Fazendas, Mineração
- Química, Petroquímica, Farmacêutica
- Médica, Life&Sciences
- Vácuo

SERIE 60000

RACCORDI AUTOMATICI IN ACCIAIO INOX AISI 316 L
 STAINLESS STEEL AISI 316 L PUSH-IN FITTINGS
 STECKVERSCHRAUBUNGEN AUS EDELSTAHL AISI 316 L
 RACCORDS INSTANTANÉS EN ACIER INOXYDABLE AISI 316 L
 RACORDAJE AUTOMÁTICO EN ACERO INOXIDABLE AISI 316 L
 CONEXÕES PUSH-IN EM AÇO INOX AISI 316 L



CARATTERISTICHE TECNICHE
 TECHNICAL CHARACTERISTICS
 TECHNISCHE ANGABEN
 CARACTÉRISTIQUES TECHNIQUES
 CARACTERÍSTICAS TÉCNICAS
 CARACTERÍSTICAS TÉCNICAS



Norma di Riferimento
 Reference standard
 Entspricht der Norm
 Norme de référence
 Normativa de referencia
 Norma de referência

1907/2006 REACH ✓	2011/65/CE RoHS ✓	PED 2014/68/UE	M.O.C.A. 1935/2004 CE
ISO 14743:2020	SILICON FREE	NSF/ANSI 169 NSF	

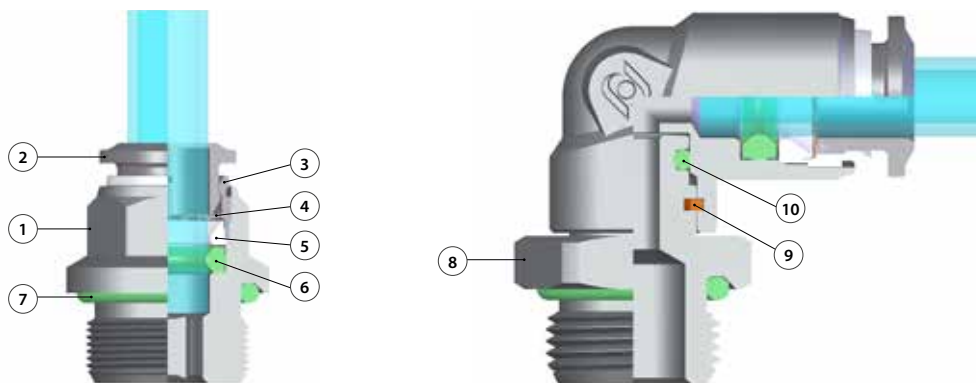

Materiali e Componenti	IT	Component Parts and Materials	GB	Komponenten und Materialien	DE
1 Corpo in Acciaio inox AISI 316 L		1 AISI 316 L Steel Body		1 Körper Edelstahl AISI 316 L	
2 Spintore sgancio tubo in Acciaio inox AISI 316 L		2 AISI 316 L Steel Collet		2 Rohr Lösering Edelstahl AISI 316 L	
3 Capsula in Acciaio inox AISI 316 L		3 AISI 316 L Steel Capsule		3 Haltering Edelstahl AISI 316 L	
4 Pinza d'aggraffaggio in Acciaio inox AISI 316 L		4 AISI 316 L Steel Clamping washer		4 Zahnscheibe Edelstahl AISI 316 L	
5 Anello di sicurezza in PPSU		5 PPSU Safety ring		5 Sicherungsring PPSU	
6 Guarnizione in FKM alimentare		6 Food FKM molded seal		6 FKM Lebensmittel	
7 Guarnizione filetto in FKM alimentare		7 Food FKM Thread packing		7 Gewindeabdichtung FKM Lebensmittel	
8 Basetta Filettata in Acciaio inox AISI 316 L		8 Base Threaded AISI 316 L Steel		8 Gewindebasis Edelstahl AISI 316 L	
9 Seeger		9 Seeger		9 Seeger	
10 Guarnizione in FKM alimentare		10 Food FKM molded seal		10 Lippendichtung FKM	
Matériaux et Composants	FR	Materiales y Componentes	ES	Materiais e Componentes	PT
1 Corps: AISI 316 L		1 Cuerpo en Acero inox AISI 316 L		1 Corpo em Aço inox AISI 316 L	
2 Poussoir: AISI 316 L		2 Anillo de extracción en Acero inox AISI 316 L		2 Anilha em Aço inox AISI 316 L	
3 Capsule de retenue: AISI 316 L		3 Cápsula en Acero inox AISI 316 L		3 Cápsula em Aço inox AISI 316 L	
4 Rondelle d'accrochage: AISI 316 L		4 Pinza de agarre en Acero inox AISI 316 L		4 Pinça de travamento em Aço Inox AISI 316 L	
5 Anneau de sécurité: PPSU		5 Anillo de seguridad en PPSU		5 Anel de segurança em PPSU	
6 Joint torique: FKM conforme alimentaire		6 Junta de forma en FKM alimentaria		6 Vedação em FKM alimentício	
7 Joint d'étanchéité du filetage: FKM conforme alimentaire		7 Junta rosca en FKM alimentaria		7 Vedação em FKM alimentício	
8 Bague de sécurité: AISI 316 L		8 Base roscada en Acero inox AISI 316 L		8 Base roscada em Aço inox AISI 316 L	
9 Seeger		9 Seeger		9 Seeger	
10 Joint en FKM conforme alimentaire		10 Junta en FKM alimentaria		10 Vedação em FKM alimentício	



Pressioni

- Pressures
- Druckbereich
- Pressions
- Presiones
- Pressões

- 0.99 bar (-0.099 MPa)
20 bar (2.0 MPa)



Temperature

- Temperatures
- Temperatur
- Températures
- Temperaturas
- Temperaturas

- 15 °C
+ 190 °C



Fluidi compatibili

Aria compressa / Vuoto
Fluidi per Industria alimentare e chimica compatibili con i componenti del raccordo.

Fluids

Compressed air / Vacuum
Fluid for food and chemical industry compatible with fitting components.

Geeignete Medien

Druckluft / Vakuum
Medien für die Lebensmittel- und chemische Industrie, die beständig mit den Komponenten der Verschraubungen sind.

Fluides compatibles

Air comprimé / Vide
Fluides alimentaires et chimiques compatibles avec les matériaux constituant les raccords.

Fluidos compatibles

Aire comprimido / Vacío
Fluidos para industria alimentaria y química compatibles con los componentes del racor.

Fluidos compatíveis

Ar comprimido / Vácuo
Fluidos para Indústria alimentícia e química compatíveis com os componentes da conexão.



Tubi di Collegamento

IT

Tubi in materiale plastico:
PA6, PA11, PA12, Polietilene, *Poliuretano, PTFE, FEP.
*Utilizzo da 90 a 98 Shore, per la massima prestazione è consigliato 98 Shore A.

Connection Tubes

GB

Plastic tubes:
PA6, PA11, PA12, Polyethylene, *Polyurethane, PTFE, FEP.
*Use from 90 to 98 Shore, for maximum performance is recommended 98 Shore A.

Geeignete Rohre

DE

Kunststoffrohre:
PA6, PA11, PA 12, Polyethylene, *Polyurethan, PTFE, FEP.
*Verwenden Sie 90 bis 98 Shore, für maximale Leistung wird 98 Shore A empfohlen.

Tubes Conseillés

FR

Tubes plastiques:
PA6, PA11, PA12, Polyéthylène, *Polyuréthane, PTFE, FEP.
*Utilisation de 90 à 98 Shore, pour une performance maximale recommandée 98 Shore A.

Tubos de Conexión

ES

Tubos en material plástico:
PA6, PA11, PA 12, Polietileno, *Poliuretano, PTFE, FEP.
*Uso de 90 a 98 Shore, para un máximo rendimiento se recomienda 98 Shore A.

Tubos de Conexão

PT

Tubos em material plástico:
PA6, PA11, PA12, Polietileno, *Poliuretano, PTFE, FEP.
*Uso de 90 a 98 Shore, para o desempenho máximo é recomendado 98 Shore A.



Filettatura

IT

Gas conica conforme ISO 7.1, BS 21, DIN 2999
Gas cilindrica conforme ISO 228 Classe A.
Metrica conforme ISO R/262.

Threads

GB

Tapered gas in conformity with ISO 7.1, BS 21, DIN 2999.
Parallel gas in conformity with ISO 228 Class A.
Metric in conformity with ISO R/262.

Gewindearten

DE

Konisches Gewinde nach Norm ISO 7.1, BS 21, DIN 2999
Zylindrisches Gewinde nach Norm ISO 228 Classe A.
Metrisches Gewinde nach Norm ISO R/262.

Filetages

FR

Filetage conique conforme: ISO 7.1, BS 21, DIN 2999.
Filetage cylindrique conforme: ISO 228 Classe A.
Filetage métrique conforme: ISO R/262.

Roscas

ES

Gas cónica conforme ISO 7.1, BS 21, DIN 2999
Gas cilíndrica conforme ISO 228 Clase A.
Métrica conforme ISO R/262.

Roscas

PT

Gas cônica conforme ISO 7.1, BS 21, DIN 2999
Gas paralela conforme ISO 228 Classe A.
Métrica conforme ISO R/262.



Coppia di serraggio

- Torque specifications
- Angaben Drehmoment
- Couple de serrage
- Par de apriete
- Especificações de Torque



ISO 228

MISURA MEASURE GRÖSSE DIMENSIONS MEDIDA MEDIDA	COPPIA CONSIGLIATA Nm RECOMMENDED TORQUE Nm EMPFOHLENES DREHMOMENT Nm COUPLE DE SERRAGE Nm PAR ACONSEJADO Nm TORQUE RECOMENDADO Nm
M5	0,8
1/8	3
1/4	9
3/8	10
1/2	12

I valori di rottura possono variare in base all'articolo
Breaking values may vary according to the item
Die maximal werte dienen nur zu informationszwecken
Les valeurs maximales sont présentées à titre indicatif
Los valores de rotura pueden variar en función del artículo
Os valores de ruptura podem variar em função do item

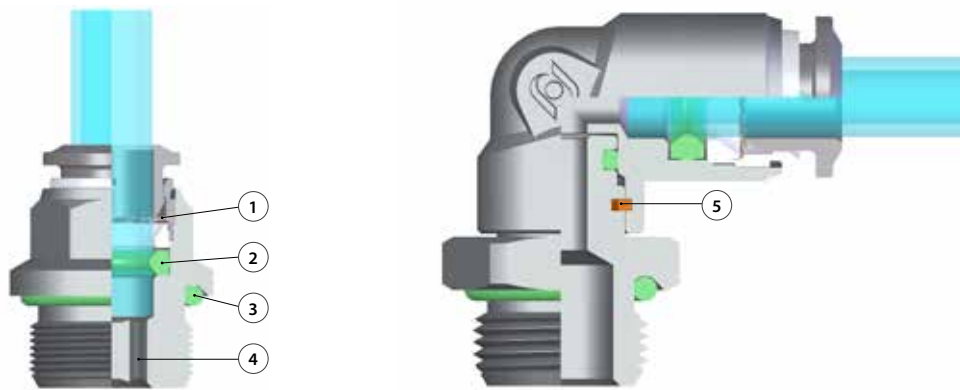

Vantaggi

IT

- 1 La pinza in acciaio inox garantisce il perfetto aggraffaggio di tubi di qualsiasi materiale senza danneggiarne la superficie. Il collegamento tra tubo e raccordo assicura una tenuta totale anche in condizioni di urti e vibrazioni.
- 2 La particolare geometria della guarnizione permette inoltre l'utilizzo dei raccordi anche con il vuoto.
- 3 Tutte le filettature di questa serie sono state dotate di elementi di tenuta che permettono l'immediato utilizzo dei raccordi riducendo notevolmente i tempi di installazione.
- 4 Tutti i raccordi dritti possono essere montati anche con chiave esagonale ed è possibile utilizzarli anche in spazi molto ridotti.
- 5 Raccordo orientabile con anello di sicurezza interno. Garantisce maggiore durata alla rotazione e trazione.

Advantages

GB

- 1 The washer is made in stainless steel ensures the perfect tube clamping with every kinds of materials without damage the surface. The connection between the tube and the fitting ensure a total tightness even in severe conditions such as impact and vibrations.
- 2 The particular geometric shape of the seal ensure the perfect tightness even with vacuum.
- 3 All of threads from this range have been equipped with tightening parts which allow the direct assembly of the fittings, reducing the installation time.
- 4 All the straight fittings can be assembled also with Allen wrench and it is possible to use them in reduced spaces.
- 5 Orienting fitting with safety ring inside. Improved durability to the rotation and traction.

Vorteile

DE

- 1 Konisches Gewinde "kurz" Die Zahnscheibe sorgt für eine perfekte Halterung des Rohres ohne die Oberfläche zu beschädigen. Die Dichtheit zwischen Rohr und Verschraubung ist auch bei Erschütterungen und Vibrationen gewährleistet.
- 2 Die besondere Geometrie der Dichtung ermöglicht auch die Anwendung der Verschraubungen in Verbindung mit Vakuum.
- 3 Alle Verschraubungen in dieser Serie sind mit Gewindeabdichtungen ausgestattet, die den sofortigen Einsatz ermöglichen und daher die Montagezeit stark reduzieren.
- 4 Alle geraden Verschraubungen können auch mit Inbusschlüsseln montiert werden, daher kleiner Lochabstand möglich.
- 5 Flexible Montage mit Sicherungsring innen. Verbesserte Beständigkeit gegenüber der Drehung und Traktions.

Avantages

FR

- 1 La rondelle en acier inoxydable garantit la parfaite tenue du tube quelle que soit la matière et sans l'endommager. La connexion entre le tube et le raccord assure une étanchéité totale même dans des conditions d'impact ou de vibrations.
- 2 La spécificité géométrique du joint permet l'utilisation des raccords avec le vide.
- 3 Tous les filetages de cette série sont équipés d'éléments d'étanchéité qui permettent l'utilisation immédiate des raccords réduisant ainsi le temps d'installation.
- 4 Tous les raccords droits peuvent être aussi montés avec une clé hexagonale pour permettre une utilisation dans des espaces réduits.
- 5 Accessoire de fixation réglable avec anneau de sécurité à l'intérieur. Amélioration de la durée de la rotation et de traction.

Ventajas

ES

- 1 La pinza en acero inox garantiza el perfecto agarre del tubo de cualquier material sin perjudicar la superficie. La conexión entre tubo y racor asegura una estanqueidad total aun en condiciones de impacto o vibración.
- 2 La particular geometría de la junta garantiza una perfecta estanqueidad incluso en vacío.
- 3 Todas las rosas de esta serie están fabricadas con junta de cierre que permite la inmediata utilización del racor reduciendo notablemente el tiempo de instalación.
- 4 Todos los racores rectos pueden montarse también con llave hexagonal y es posible utilizarlos incluso en espacios muy reducidos.
- 5 Montaje ajustable con sistema de seguridad interior. La mejora de la durabilidad a la rotación y tracción.

Vantagens

PT

- 1 A pinça em aço-inox garante o perfeito travamento do tubo de qualquer material sem danificar a superfície do mesmo. A conexão entre o tubo e a conexão assegura uma vedação total também em condições de impactos e vibrações.
- 2 A geometria particular da vedação permite a utilização da conexão também para aplicações com vácuo.
- 3 Todas as rosas desta série são dotadas de elementos de vedação, o que permite a imediata utilização das conexões, reduzindo notavelmente o tempo de instalação.
- 4 Todas as conexões retas podem ser montadas também com chave allenando possível montagem das mesmas em espaços bem reduzidos.
- 5 Montagem ajustável com anel de segurança dentro. A durabilidade melhorada para a rotação e tração.

60000

RACCORDO DIRITTO MASCHIO CONICO

STRAIGHT MALE ADAPTOR (TAPER)
GERADE EINSCHRAUBVERSCHRAUBUNG KONISCH
RACCORD DROIT MÂLE, CONIQUE
RACOR RECTO MACHO CÔNICO
CONEXÃO RETA MACHO COM ROSCA CÔNICA

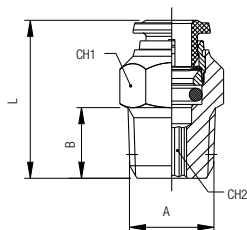

Code	Tube	A	B	L	CH1	CH2	Pack.
60000 00 001	4	1/8	7.5	19	10	3	5
60000 00 002	4	1/4	11	23	14	3	5
60000 00 003	6	1/8	7.5	22.5	13	4	5
60000 00 004	6	1/4	11	24.5	14	4	5
60000 00 005	8	1/8	7.5	25.5	14	5	5
60000 00 006	8	1/4	11	25	14	6	5
60000 00 007	10	1/4	11	30.5	17	7	2
60000 00 008	10	3/8	11.5	28	17	8	2
60000 00 009	12	3/8	11.5	33.5	21	9	2
60000 00 010	12	1/2	14	32	22	10	2

60020

RACCORDO DIRITTO MASCHIO CILINDRICO

STRAIGHT MALE ADAPTOR (PARALLEL)
GERADE EINSCHRAUBVERSCHRAUBUNG ZYLINDRISCH
RACCORD DROIT MÂLE, CYLINDRIQUE
RACOR RECTO MACHO CILÍNDRICO CON TÓRICA
CONEXÃO RETA MACHO COM ROSCA PARALELA

New

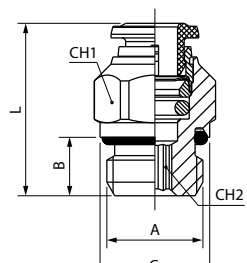

Code	Tube	A	B	C	L	CH1	CH2	Pack.
60020 00 011	4	M5	4	8	20	10	2	5
60020 00 001	4	1/8	6	13	19.5	10	3	5
60020 00 002	4	1/4	8	15	19.5	15	3	5
60020 00 013	6	M5	4	10	23	12	2	5
60020 00 003	6	1/8	6	13	23.5	13	4	5
60020 00 004	6	1/4	8	15	23.5	15	4	5
60020 00 005	8	1/8	6	13	25.5	14	5	5
60020 00 006	8	1/4	8	15	23.5	15	6	5
60020 00 007	10	1/4	8	16	30	17	8	2
60020 00 008	10	3/8	9	20	27	17	8	2
60020 00 012	10	1/2	10	25	30	22	8	2
60020 00 009	12	3/8	9	21	34	21	8	2
60020 00 010	12	1/2	10	25	31	22	10	2
60020 00 014	14	1/2	10	25	32	22	11	2
60020 00 015	16	3/8	9	24	36	24	10	2
60020 00 016	16	1/2	10	25	37	25	12	2

60030

RACCORDO DIRITTO FEMMINA

STRAIGHT FEMALE ADAPTOR
AUFSCHRAUBVERSCHRAUBUNG
RACCORD DROIT, TARAUEE
RACOR RECTO HEMBRA
CONEXÃO RETA COM ROSCA FÊMEA

New

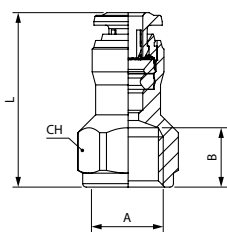

Code	Tube	A	B	L	CH	Pack.
60030 00 001	4	1/8	8.5	25	13	5
60030 00 003	6	1/8	8.5	26	13	5
60030 00 004	6	1/4	11	29.5	16	5
60030 00 005	8	1/8	8.5	27	15	5
60030 00 006	8	1/4	11	29.5	17	5

60040

RACCORDO DIRITTO INTERMEDIO

STRAIGHT CONNECTOR
VERBINDUNGSVERSCHRAUBUNG
RACCORD UNION DOUBLE
RACOR RECTO INTERMEDIO
CONEXÃO RETA TUBO-TUBO

New

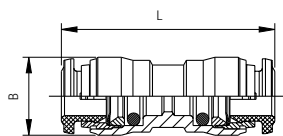

Code	Tube	Tube	L	B	Pack.
60040 00 001	4	4	31	10.5	5
60040 00 007	6	4	31	12.5	5
60040 00 002	6	6	35	12.5	5
60040 00 008	8	6	34.5	14.5	5
60040 00 003	8	8	36.5	14.5	5
60040 00 009	10	8	38	17.5	2
60040 00 004	10	10	42	17.5	2
60040 00 010	12	10	44	20.5	2
60040 00 005	12	12	48	20.5	2
60040 00 006	14	14	44.5	21.5	2
60040 00 012	16	12	52.5	24	2
60040 00 011	16	16	53.5	24	2

60050

RACCORDO DIRITTO INTERMEDIO DI ATTRAVERSAMENTO

BULKHEAD CONNECTOR
SCHOTTVERSCHRAUBUNG
RACCORD TRAVERSÉE DE CLOISON
RACOR RECTO INTERMEDIO PASATABIQUES
CONEXÃO PASSA-MURO RETA TUBO-TUBO

New

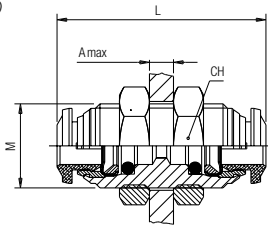

Code	Tube	M	L	CH	A max	Pack.
60050 00 001	4	M12x1	31	17	7	5
60050 00 002	6	M14x1	35	17	9.5	5
60050 00 003	8	M16x1	37	19	10.5	5
60050 00 004	10	M20x1	42	24	12.5	2
60050 00 005	12	M22x1	48	26	16.5	2
60050 00 007	16	M27x1,5	53.5	32	10.5	2

60110

RACCORDO A L ORIENTABILE MASCHIO CONICO

ORIENTING ELBOW MALE ADAPTOR (TAPER)
WINKELVERSCHRAUBUNG KONISCH (DREHBAR)
EQUERRE MÂLE ORIENTABLE, CONIQUE
RACOR A L ORIENTABLE MACHO CÓNICO
CONEXÃO EM "L" ORIENTÁVEL COM ROSCA MACHO CÔNICA

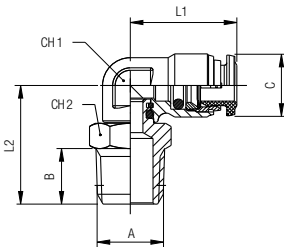

Code	Tube	A	B	C	L1	L2	CH1	CH2	Pack.
60110 00 001	4	1/8	7.5	10	18	20	9	11	10
60110 00 002	4	1/4	11	10	18	24	9	14	10
60110 00 003	6	1/8	7.5	12.5	21	21	11	13	10
60110 00 004	6	1/4	11	12.5	21	26	11	14	10
60110 00 005	8	1/8	7.5	14.5	22.5	24.5	12	11	10
60110 00 006	8	1/4	11	14.5	22.5	28.5	12	14	10
60110 00 007	10	1/4	11	17.5	26	29.5	16	14	10
60110 00 008	10	3/8	11.5	17.5	26	31	16	17	10
60110 00 009	10	1/2	14	17.5	26	34.5	16	22	10
60110 00 010	12	3/8	11.5	20.5	30.5	33	19	18	10
60110 00 011	12	1/2	14	20.5	30.5	35.5	19	22	10

Fino ad esaurimento scorte

Until the end stock

Nur solange vorrat

Livvable jusqu'à épuisement du stock

Hasta fin de stock

Ate fim do stock

60110X

RACCORDO A L ORIENTABILE MASCHIO CONICO

ORIENTING ELBOW MALE ADAPTOR (TAPER)
WINKELVERSCHRAUBUNG KONISCH (DREHBAR)
EQUERRE MÂLE ORIENTABLE, CONIQUE
RACOR A L ORIENTABLE MACHO CÓNICO
CONEXÃO EM "L" ORIENTÁVEL COM ROSCA MACHO CÔNICA

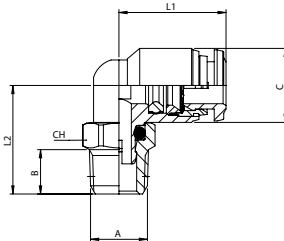

Code	Tube	A	B	C	L1	L2	CH	Pack.
60110 X0 001	4	1/8	7.5	10	15.5	17	11	5
60110 X0 002	4	1/4	11	10	15.5	21	14	5
60110 X0 003	6	1/8	7.5	12.5	18	18.5	11	5
60110 X0 004	6	1/4	11	12.5	18	22.5	14	5
60110 X0 005	8	1/8	7.5	14.5	20	23	12	5
60110 X0 006	8	1/4	11	14.5	20	23.5	14	5
60110 X0 007	10	1/4	11	17	23.5	28.5	15	2
60110 X0 008	10	3/8	11.5	17	23.5	26	17	2
60110 X0 009	10	1/2	14	17	23.5	29.5	22	2
60110 X0 010	12	3/8	11.5	20.5	27.5	32.5	17	2
60110 X0 011	12	1/2	14	20.5	27.5	31.5	22	2

60115

RACCORDO A L ORIENTABILE MASCHIO CILINDRICO

ORIENTING ELBOW MALE ADAPTOR (PARALLEL)
WINKELVERSCHRAUBUNG ZYLINDRISCH (DREHBAR)
EQUERRE ORIENTABLE MÂLE, CYLINDRIQUE
RACOR A L ORIENTABLE MACHO CILÍNDRICO CON TÓRICA
CONEXÃO MACHO EM L ORIENTÁVEL COM ROSCA PARALELA

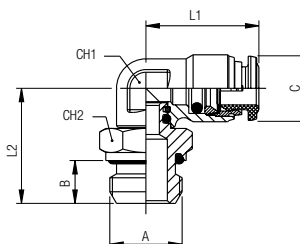

Code	Tube	A	B	C	L1	L2	CH1	CH2	Pack.
60115 00 012	4	M5	4	10	18	18.5	9	8	10
60115 00 001	4	1/8	6	10	18	19.5	9	13	10
60115 00 002	4	1/4	8	10	18	22.5	9	15	10
60115 00 013	6	M5	4	12.5	21	20.5	11	10	10
60115 00 003	6	1/8	6	12.5	21	21	11	13	10
60115 00 004	6	1/4	8	12.5	21	24	11	15	10
60115 00 005	8	1/8	6	14.5	22.5	24	12	13	10
60115 00 006	8	1/4	8	14.5	22.5	25.5	12	15	10
60115 00 007	10	1/4	8	17.5	26	28.5	16	15	10
60115 00 008	10	3/8	9	17.5	26	29	16	21	10
60115 00 009	10	1/2	10	17.5	26	33.5	16	22	10
60115 00 010	12	3/8	9	20.5	30.5	30.5	19	21	10
60115 00 011	12	1/2	10	20.5	30.5	35	19	22	10

Fino ad esaurimento scorte

Until the end stock

Nur solange vorrat

Livvable jusqu'à épuisement du stock

Hasta fin de stock

Ate fim do stock

60115X

RACCORDO A L ORIENTABILE MASCHIO CILINDRICO

ORIENTING ELBOW MALE ADAPTOR (PARALLEL)
 WINKELVERSCHRAUBUNG ZYLINDRISCH (DREHBAR)
 EQUERRE ORIENTABLE MÂLE, CYLINDRIQUE
 RACOR A L ORIENTABLE MACHO CILÍNDRICO CON TÓRICA
 CONEXÃO MACHO EM L ORIENTÁVEL COM ROSCA PARALELA

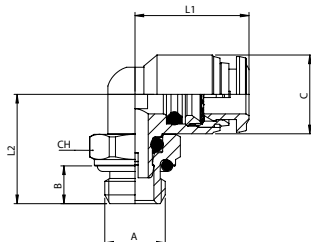

Code	Tube	A	B	C	L1	L2	CH	Pack.
60115 X0 012	4	M5	4	10	15.5	16	8	5
60115 X0 001	4	1/8	6	10	15.5	16	13	5
60115 X0 002	4	1/4	8	10	15.5	18.5	15	5
60115 X0 013	6	M5	4	12.5	18	17.5	8	5
60115 X0 003	6	1/8	6	12.5	18	17.5	13	5
60115 X0 004	6	1/4	8	12.5	18	20	15	5
60115 X0 015	6	3/8	9	12.5	18	23	20	5
60115 X0 005	8	1/8	6	14.5	20	23	13	5
60115 X0 006	8	1/4	8	14.5	20	21	15	5
60115 X0 016	8	3/8	9	14.5	20	24	20	5
60115 X0 007	10	1/4	8	17	23.5	27.5	15	2
60115 X0 008	10	3/8	9	17	23.5	25	20	2
60115 X0 009	10	1/2	10	17	23.5	26.5	25	2
60115 X0 010	12	3/8	9	20.5	27.5	30.5	20	2
60115 X0 011	12	1/2	10	20.5	27.5	28.5	25	2
60115 X0 014	14	1/2	10	21.5	27.5	33	25	2
60115 X0 017	16	1/2	10	24	33	36	25	2

60130

RACCORDO A L INTERMEDIO

ELBOW CONNECTOR
 WINKELVERSCHRAUBUNG
 RACCORD EQUERRE
 RACOR A L INTERMEDIO
 CONEXÃO EM "L" TUBO-TUBO

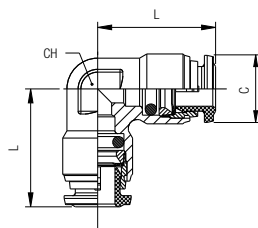

Code	Tube	C	L	Pack.
60130 00 001	4	10	18	10
60130 00 002	6	12.5	21	10
60130 00 003	8	14.5	22.5	10
60130 00 004	10	17.5	26	10
60130 00 005	12	20.5	30.5	10

Fino ad esaurimento scorte
 Until the end stock
 Nur solange vorrat
 Livrable jusqu'à épuisement du stock
 Hasta fin de stock
 Até fim do stock

60130X

RACCORDO A L INTERMEDIO

ELBOW CONNECTOR
 WINKELVERSCHRAUBUNG
 RACCORD EQUERRE
 RACOR A L INTERMEDIO
 CONEXÃO EM "L" TUBO-TUBO

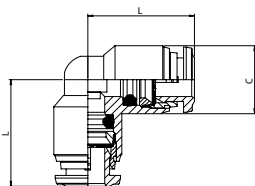

Code	Tube	C	L	Pack.
60130 X0 001	4	10	16	5
60130 X0 002	6	12.5	19.5	5
60130 X0 003	8	14.5	21	5
60130 X0 004	10	17	24.5	2
60130 X0 005	12	20.5	29	2
60130 X0 006	14	21.5	28.5	2
60130 X0 007	16	24	33	2

60210

RACCORDO A T ORIENTABILE MASCHIO CONICO

ORIENTING TEE MALE ADAPTOR (TAPER)-CENTRE LEG
 T-EINSCHRAUBVERSCHRAUBUNG KONISCH (DREHBAR)
 TÉ ORIENTABLE À PIQUAGE MÂLE CENTRAL, CONIQUE
 RACOR A T ORIENTABLE MACHO CENTRAL CÓNICO
 CONEXÃO EM "T" ORIENTÁVEL COM ROSCA MACHO CÔNICA

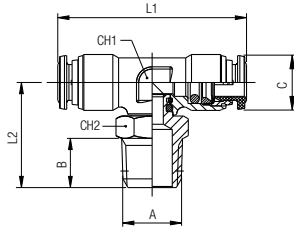

Code	Tube	A	B	C	L1	L2	CH1	CH2	Pack.
60210 00 001	4	1/8	7.5	10	36	20.5	9	11	10
60210 00 002	4	1/4	11	10	36	24	9	14	10
60210 00 003	6	1/8	7.5	12.5	42	21	11	13	10
60210 00 004	6	1/4	11	12.5	42	26	11	14	10
60210 00 005	8	1/8	7.5	14.5	45	25	12	11	10
60210 00 006	8	1/4	11	14.5	45	29	12	14	10
60210 00 007	10	1/4	11	17.5	52	30	16	14	10
60210 00 008	10	3/8	11.5	17.5	52	31.5	16	17	10
60210 00 009	10	1/2	14	17.5	52	35	16	22	10
60210 00 010	12	3/8	11.5	20.5	61	33	19	18	10
60210 00 011	12	1/2	14	20.5	61	35.5	19	22	10

Fino ad esaurimento scorte
 Until the end stock
 Nur solange vorrat
 Livrable jusqu'à épuisement du stock
 Hasta fin de stock
 Ate fim do stock

60210X

RACCORDO A T ORIENTABILE MASCHIO CONICO

ORIENTING TEE MALE ADAPTOR (TAPER)-CENTRE LEG
 T-EINSCHRAUBVERSCHRAUBUNG KONISCH (DREHBAR)
 TÉ ORIENTABLE À PIQUAGE MÂLE CENTRAL, CONIQUE
 RACOR A T ORIENTABLE MACHO CENTRAL CÓNICO
 CONEXÃO EM "T" ORIENTÁVEL COM ROSCA MACHO CÔNICA

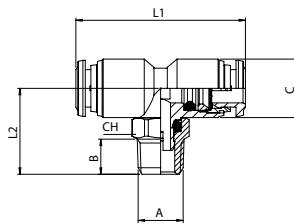

Code	Tube	A	B	C	L1	L2	CH	Pack.
60210 X0 001	4	1/8	7.5	10	30.5	17	11	5
60210 X0 002	4	1/4	11	10	30.5	21	14	5
60210 X0 003	6	1/8	7.5	12.5	36	20.5	11	5
60210 X0 004	6	1/4	11	12.5	36	22.5	14	5
60210 X0 005	8	1/8	7.5	14.5	40	23	12	5
60210 X0 006	8	1/4	11	14.5	40	23.5	14	5
60210 X0 007	10	1/4	11	17	47	28.5	15	2
60210 X0 008	10	3/8	11.5	17	47	26	17	2
60210 X0 009	10	1/2	14	17	47	29.5	22	2
60210 X0 010	12	3/8	11.5	20.5	55	32.5	17	2
60210 X0 011	12	1/2	14	20.5	55	31.5	22	2

60215

RACCORDO A T ORIENTABILE MASCHIO CILINDRICO

ORIENTING TEE MALE ADAPTOR (PARALLEL)-CENTRE LEG
 T-EINSCHRAUBVERSCHRAUBUNG ZYLINDRISCH (DREHBAR)
 TÉ ORIENTABLE À PIQUAGE MÂLE CENTRAL, CYLINDRIQUE
 RACOR A T ORIENTABLE MACHO CENTRAL CILÍNDRICO CON TÓRICA
 CONEXÃO EM "T" ORIENTÁVEL COM ROSCA MACHO PARALELA

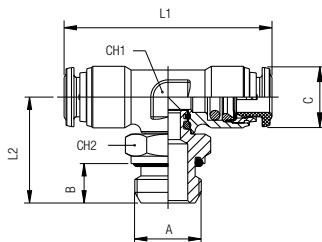

Code	Tube	A	B	C	L1	L2	CH1	CH2	Pack.
60215 00 012	4	M5	4	10	36	18.5	9	8	10
60215 00 001	4	1/8	6	10	36	18.5	9	13	10
60215 00 002	4	1/4	8	10	36	22	9	15	10
60215 00 003	6	1/8	6	12.5	42	21	11	13	10
60215 00 004	6	1/4	8	12.5	42	24	11	15	10
60215 00 005	8	1/8	6	14.5	45	24.5	12	13	10
60215 00 006	8	1/4	8	14.5	45	26	12	15	10
60215 00 007	10	1/4	8	17.5	52	29	16	15	10
60215 00 008	10	3/8	9	17.5	52	29	16	21	10
60215 00 009	10	1/2	10	17.5	52	34	16	22	10
60215 00 010	12	3/8	9	20.5	61	30.5	19	21	10
60215 00 011	12	1/2	10	20.5	61	35	19	22	10

Fino ad esaurimento scorte
 Until the end stock
 Nur solange vorrat
 Livrable jusqu'à épuisement du stock
 Hasta fin de stock
 Ate fim do stock

60215X

RACCORDO A T ORIENTABILE MASCHIO CILINDRICO

ORIENTING TEE MALE ADAPTOR (PARALLEL)-CENTRE LEG
 T-EINSCHRAUBVERSCHRAUBUNG ZYLINDRISCH (DREHBAR)
 TÉ ORIENTABLE À PIQUAGE MÂLE CENTRAL, CYLINDRIQUE
 RACOR A T ORIENTABLE MACHO CENTRAL CILÍNDRICO CON TÓRICA
 CONEXÃO EM "T" ORIENTÁVEL COM ROSCA MACHO PARALELA

New

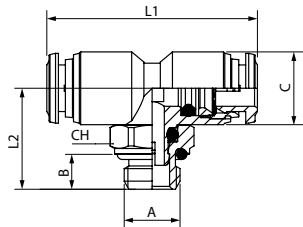

Code	Tube	A	B	C	L1	L2	CH	Pack.
60215 X0 012	4	M5	4	10	30.5	16	8	5
60215 X0 001	4	1/8	6	10	30.5	16	13	5
60215 X0 002	4	1/4	8	10	30.5	18.5	15	5
60215 X0 013	6	M5	4	12.5	36	17.5	8	5
60215 X0 003	6	1/8	6	12.5	36	17.5	13	5
60215 X0 004	6	1/4	8	12.5	36	20	15	5
60215 X0 005	8	1/8	6	14.5	40	23	13	5
60215 X0 006	8	1/4	8	14.5	40	21	15	5
60215 X0 007	10	1/4	8	17	47	27.5	15	2
60215 X0 008	10	3/8	9	17	47	25	20	2
60215 X0 009	10	1/2	10	17	47	26.5	25	2
60215 X0 010	12	3/8	9	20.5	55	30.5	20	2
60215 X0 011	12	1/2	10	20.5	55	28.5	25	2
60215 X0 014	14	1/2	10	21.5	55.5	33	25	2
60215 X0 017	16	1/2	10	24	65.5	36.5	25	2

60230

RACCORDO A T INTERMEDIO

TEE CONNECTOR
 T-ANSCHLUSS
 RACCORD TÉ
 RACOR A T INTERMEDIO
 CONEXÃO EM "T" TUBO-TUBO

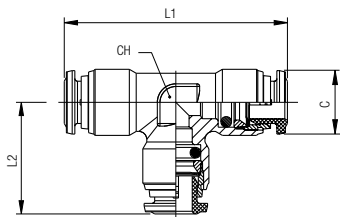

Code	Tube	C	L1	L2	CH	Pack.
60230 00 001	4	10	36	18	9	10
60230 00 002	6	12.5	42	21	11	10
60230 00 003	8	14.5	45	22.5	12	10
60230 00 004	10	17.5	52	26	16	10
60230 00 005	12	20.5	61	30.5	19	10

Fino ad esaurimento scorte
 Until the end stock
 Nur solange vorrat
 Livrable jusqu'à épuisement du stock
 Hasta fin de stock
 Até fim do stock

60230X

RACCORDO A T INTERMEDIO

TEE CONNECTOR
 T-ANSCHLUSS
 RACCORD TÉ
 RACOR A T INTERMEDIO
 CONEXÃO EM "T" TUBO-TUBO

New

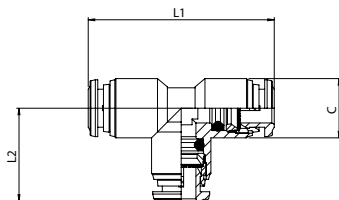

Code	Tube	C	L1	L2	Pack.
60230 X0 001	4	10	32	16	5
60230 X0 002	6	12.5	39	19.5	5
60230 X0 003	8	14.5	42	21	5
60230 X0 004	10	17	49	24.5	2
60230 X0 005	12	20.5	57.5	29	2
60230 X0 006	14	21.5	57.5	28.5	2
60230 X0 007	16	24	65.5	33	2

60310X

RACCORDO A Y INTERMEDIO

Y CONNECTOR
 Y-ANSCHLUSS
 RACCORD Y SIMPLE
 RACOR A Y INTERMEDIO
 CONEXÃO EM "Y" TUBO-TUBO

New

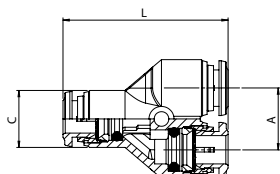

Code	D	A	C	L	Pack.
60310 X0 001	4	11	10	31	2
60310 X0 002	6	13.5	12.5	36	2
60310 X0 003	8	15.5	14.5	40	2
60310 X0 004	10	18.5	17	47.5	2
60310 X0 005	12	21.5	20.5	56.5	2
60310 X0 007	16	25	24	62	2

60600

ADATTATORE MASCHIO CILINDRICO

MALE ADAPTOR PARALLEL

EINSCHRAUBSTECKVERSCHRAUBUNG ZYLINDRISCH

ADAPTATEUR ENCLIQUETABLE MÂLE, CYLINDRIQUE

ADAPTADOR MACHO CILÍNDRICO

ADAPTADOR COM ROSCA MACHO PARALELA

New

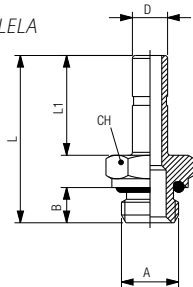

Code	D	A	B	L	L1	CH	Pack.
60600 00 007	6	1/8	6	28.5	17	13	5
60600 00 010	8	1/4	8	31.5	18	16	5
60600 00 011	8	3/8	9	33.5	18	20	5
60600 00 013	10	1/4	8	35.5	22	16	2
60600 00 014	10	3/8	9	37.5	22	20	2
60600 00 016	12	3/8	9	40	24.5	20	2
60600 00 017	12	1/2	10	42.5	24.5	24	2

60700

RIDUZIONE

REDUCER

REDUZIERUNG

RÉDUCTION ENCLIQUETABLE

REDUCCIÓN

REDUÇÃO

New

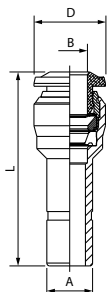

Code	A	B	L	D	Pack.
60700 00 002	6	4	30.5	10.5	5
60700 00 003	8	4	33	10.5	5
60700 00 004	8	6	34	12.5	5
60700 00 001	10	6	36	12.5	5
60700 00 005	10	8	38	14.5	5
60700 00 006	12	8	36	14.5	5
60700 00 007	12	10	42	17.5	2
60700 00 012	16	10	46	17.5	2

60871

INCISORE TUBO

ENGRAVER TUBE

GRAVEUR TUBE

TUBE DE GRAVEUR

TUBO DE GRABADOR

TUBO DE GRAVADOR

New



Code	Ø	Pack.
60871 00 001	4 - 16	1

Dimensioni zona aggraffaggio tubi metallici per raccordi automatici

Clamping point dimensions on metallic tubes for push-in fittings

Klemmpunktangaben für metallische Rohren

Dimensions zone d'agrafage tubes métalliques

Dimensiones punto de sujeción para tubos metálicos

Dimensões ponto de fixação para tubos metálicos

Ø	A
50000 - 55000 - 60000	
4	6.2
6	7
8	8
10	9
12	10.2
14	9
16	11

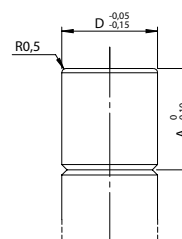

60876

LAMA DI RICAMBIO PER 60871

SPARE BLADE 60871

ERSATZKLINGEN FÜR 60871

LAMES DE RECHANGE POUR 60871

CUCHILLA DE RECAMBIO PARA 60871

LÂMINA DE REPOSIÇÃO PARA 60871

New



Code	Pack.
60876 00 01 00 00	1