





Prese ad Innesto Rapido - Quick Couplings - Schnellverschluss Kupplungen - Coupleurs Automatiques - Enchufes Rápidos - Conexões de Engate Rápido

<p>SERIE UNI ISO 6150 A-6</p>  <p>Serie 100 Pag. 15.7 - 15.10</p>	<p>SERIE MIGNON New</p>  <p>Serie 110 Pag. 15.11 - 15.16</p>	<p>SERIE UNI ISO 6150 B-12</p>  <p>Serie 120 Pag. 15.17 - 15.22</p>	<p>ITALIAN PROFILE</p>  <p>Serie 120 Pag. 15.23 - 15.28</p>
<p>SERIE UNI ISO 6150 B-15</p>  <p>Serie 130 Pag. 15.29 - 15.33</p>	<p>SERIE UNI ISO 6150 C-10</p>  <p>Serie 140 Pag. 15.34 - 15.39</p>	<p>EUROPEAN PROFILE</p>  <p>Serie 160 Pag. 15.40 - 15.45</p>	<p>SWISS PROFILE</p>  <p>Serie 170 Pag. 15.46 - 15.50</p>
<p>MIGNON PROFILE New</p>  <p>Serie 180 Pag. 15.51 - 15.54</p>	<p>MULTISOCKET New</p>  <p>Serie 190 - 63190 Pag. 15.55 - 15.61</p>	<p>JAPANESE PROFILE</p>  <p>Serie 400 Pag. 15.62 - 15.64</p>	<p>Serie 700 Pag. 15.65 - 15.67</p>
<p>SERIE UNI ISO 6150 B-17</p>  <p>Serie 710 Pag. 15.68 - 15.70</p>	<p>B-SOCKET EUROPEAN</p>  <p>Serie 720 Pag. 15.71 - 15.74</p>	<p>EUROPEAN PROFILE New</p>  <p>Serie 730 Pag. 15.75 - 15.80</p>	<p>EUROPEAN PROFILE New</p>  <p>Serie 740 Pag. 15.81 - 15.83</p>

Prese di Sicurezza ad Innesto Rapido - Safety Quick Couplings - Kupplungen Sicherheit - Coupleurs de Sécurité - Enchufes de Seguridad - Conexões de Segurança

<p>SERIE UNI ISO 6150 B-12</p>  <p>Serie 620 Pag. 15.85 - 15.88</p>	<p>ITALIAN PROFILE</p>  <p>Serie 650 Pag. 15.89 - 15.90</p>	<p>EUROPEAN PROFILE</p>  <p>Serie 660 Pag. 15.91 - 15.92</p>	<p>SWISS PROFILE</p>  <p>Serie 670 Pag. 15.93 - 15.94</p>
<p>SERIE UNI ISO 6150 B-12</p>  <p>Serie 0B120 Pag. 15.97 - 15.99</p>	<p>SERIE UNI ISO 6150 C-10</p>  <p>Serie 0B140 Pag. 15.100 - 15.102</p>	<p>EUROPEAN PROFILE New</p>  <p>Serie 0B160 Pag. 15.103 - 15.105</p>	

Giunti ad Innesto Rapido per Raffreddamento Stampi - Quick Couplings for Molding Cooling - Schnellkupplungen für Spritzgussanwendungen - Coupleurs pour Moules D'injection - Enchufes Rápidos para Refrigeración de Moldes - Conexões de Engate Rápido para Resfriamento de Moldes

<p>FRENCH PROFILE DN 8 - DN 12</p>  <p>Series 410 - 420 - 510 - 520 Pag. 15.104 - 15.110</p>	<p>INTERNATIONAL PROFILE DN 6 - DN 9</p>  <p>Series 430 - 440 - 530 - 540 Pag. 15.112 - 15.119</p>	<p>EUROPEAN PROFILE DN 6 - DN 9</p>  <p>Series 460 - 470 - 560 - 570 Pag. 15.120 - 15.127</p>	<p>6049 Pag. 15.128</p> 
--	--	--	--

Pistole di Soffiaggio - Blow Guns - Blasipistolen - Soufflettes - Pistolas Sopladoras - Pistola de Ar

 <p>Series 360 Pag. 15.130 - 15.132</p>	 <p>Series 300 Pag. 15.133 - 15.135</p>	 <p>Spare Parts Pag. 15.136</p>	 <p>Series 340 Pag. 15.137</p>
---	---	--	--

Alignep si riserva il diritto di variare modelli e ingombri senza preavviso - Alignep reserves the right to vary models and dimensions without notice - Alignep behält sich das Recht vor, Daten ohne Ankündigung zu ändern
 Alignep se reserva el derecho de modificar modelos y dimensiones sin previo aviso - Alignep se réserve le droit de modifier les données sans préavis

New

SERIE OB160 EUROPEAN PROFILE



CARATTERISTICHE TECNICHE
 TECHNICAL CHARACTERISTICS
 TECHNISCHE ANGABEN
 CARACTÉRISTIQUES TECHNIQUES
 CARACTERÍSTICAS TÉCNICAS
 CARACTERÍSTICAS TÉCNICAS



Norma di Riferimento
 Reference standard
 Entspricht der Norm
 Norme de référence
 Normativa de referencia
 Norma de referència

1907/2006
 REACH ✓

2011/65/CE
 RoHS ✓

ISO
 4414

PED
 2014/68/UE

SILICON
 FREE

CONSIGLIATA CON INNESTI ACCIAIO
 ADVISE WITH STEEL PLUG
 EMPFOHLENE STECKER AUS STAHL
 EMBOUT RECOMMANDE EN ACIER
 ACONSEJADOS CON ADAPT EN ACERO
 ACONSELHADA COM PLUG EM AÇO

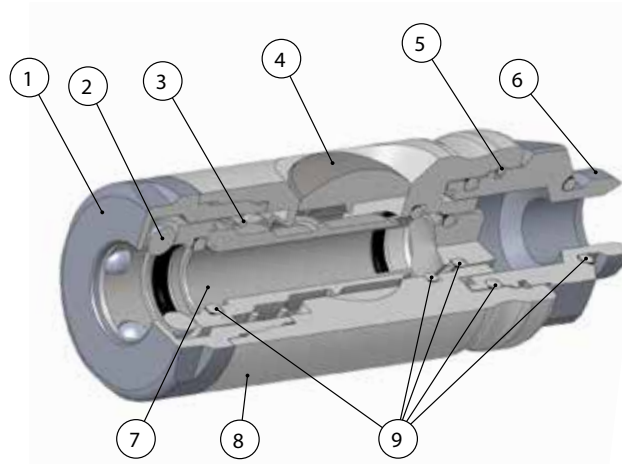

ORIENTABILE
 ORIENTING
 DREHBAR
 ORIENTABLE
 ORIENTABLE
 ORIENTÁVEL

Funzionamento	IT	Operation	GB	Operation	DE
Premere due volte il pulsante per la disconnessione in 2 fasi: 1 Scarico 2 Disconnessione		Press the 2-step disconnection button twice: 1 Disconnect 2 Disconnect		Drücken Sie 2 die Taste zum Trennen der Verbindung in 2 Schritten: 1 Trennen der Verbindung 2 Trennen der Verbindung	
Fonctionnement	FR	Operación	ES	Operação	PT
Appuyez deux fois sur la touche de déconnexion en deux étapes: 1 Déconnexion 2 Déconnexion		Pulse dos veces el botón de desconexión en 2 pasos: 1 Desconectar 2 Desconectar		Pressione duas vezes o botão de desconexão em duas etapas: 1 Desconectar 2 Desconectar	

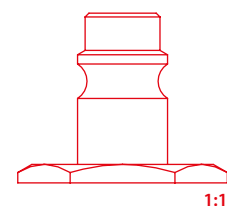
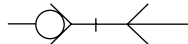
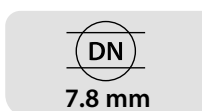

Materiali e Componenti	IT	Component Parts and Materials	GB	Komponenten und Materialien	DE
1 Anello in ottone nichelato 2 Sfera in acciaio INOX AISI 420 3 Molla contrasto otturatore in acciaio INOX AISI 302 4 Pulsante in acciaio 5 Anello in ottone 6 Attacco terminale in ottone nichelato 7 Otturatore in acciaio 8 Corpo in alluminio 9 Guarnizione O-Ring in NBR		1 Nickel-plated brass ring 2 INOX steel AISI 420 ball 3 INOX steel AISI 302 shutter thrust spring 4 Steel button 5 Brass ring 6 Nickel-plated brass coupling back part 7 Steel shutter 8 Aluminium Body 9 NBR O-ring		1 Führungsring Messing vernickelt 2 Kugel Edelstahl AISI 420 3 Verschlussfeder Edelstahl AISI 302 4 Stahl Knopf 5 Führungsring Messing 6 Einschraubkörper Messing vernickelt 7 Verschluss Stahl 8 Körper Aluminium 9 O-Ring NBR	
Matériaux et Composants	FR	Materiales y Componentes	ES	Materiais e Componentes	PT
1 Bague de guidage: laiton nickelé 2 Bille: acier inoxydable AISI 420 3 Ressort de bague: acier inoxydable AISI 302 4 Bouton en acier 5 Bague de guidage: laiton 6 Corps: laiton nickelé 7 Clapet: Acier 8 Corps: Aluminium 9 Joint torrique: NBR		1 Anillo en latón niquelado 2 Esfera en acero INOX AISI 420 3 Muelle empuje obturador en acero INOX AISI 302 4 Botón de acero 5 Anillo en latón 6 Terminal en latón niquelado 7 Obturador en Acero 8 Cuerpo en Aluminio 9 Junta tórica en NBR		1 Anel em Latão Niquelado 2 Esfera em aço INOX AISI 420 3 Mola do obturador em aço INOX AISI 302 4 Botão de aço 5 Anel em Latão 6 Conexão terminal em Latão Niquelado 7 Obturador em Aço 8 Corpo em Alumínio 9 Vedação O-Ring em NBR	



Pressione d'esercizio

Working Pressures
Betriebsdruck
Pression de service
Presión de Ejercicio
Pressão de Trabalho

0 bar (0 MPa)
15 bar (1.5 MPa)



Temperature

Temperatures
Temperatur
Températures
Temperaturas
Temperaturas

- 20 °C
+ 80 °C



Fluidi compatibili

Aria compressa
Fluids
Compressed air

Geeignete Medien
Druckluft

Fluides compatibles
Air comprimé

Fluidos compatibles
Aire comprimido

Fluidos compatíveis
Ar comprimido



Portata NI/min

Flow Rate
Durchflusswerte
Débit
Caudal de Flujo
Vazão

6 bar Δ 1	6 bar Δ 0.5	6 bar *
970	1310	2000

* Scarico libero - Exhaust Free - Kostenlose Auspuff - Échappement libre - Escape Libre - Descarga libre.



Filettatura

Gas cilindrica conforme ISO 228 Classe A.

IT

Threads

Parallel gas in conformity with ISO 228 Class A.

GB

Gewindearten

Zylindrisches Gewinde nach Norm ISO 228 Classe A.

DE

Filetages

Filetage cylindrique conforme: ISO 228 Class A.

FR

Roscas

Gas cilindrica conforme ISO 228 Clase A.

ES

Roscas

Gas paralela conforme ISO 228 Classe A.

PT

OB161

PRESA DI SICUREZZA MASCHIO CILINDRICO CON OR

SAFETY MALE CILINDRIC SOCKET WITH OR
VERSCHLUSS-KUPPLUNG SICHERHEIT MIT AUSSENGEWINDE ZYLINDRISCH MIT OR
COUPLEUR DE SÉCURITÉ MÂLE CYLINDRIQUE AVEC OR
ENCHUFE DE SEGURIDAD MACHO CILINDRICA CON OR
SOQUETE DE SEGURANÇA COM ROSCA MACHO PARALELA COM OR

Code	A	B	C	D	CH	Pack.
OB161 00 001	1/4	8	73	26	21	10
OB161 00 002	3/8	9	74	26	21	10
OB161 00 003	1/2	10	77	26	25	10

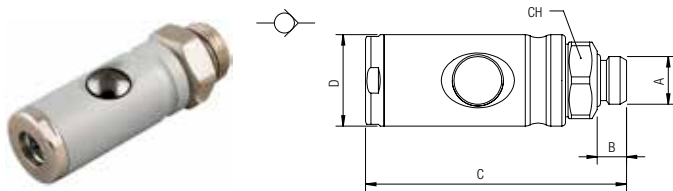

OB162

PRESA DI SICUREZZA FEMMINA

SAFETY FEMALE CILINDRIC SOCKET
VERSCHLUSS-KUPPLUNG SICHERHEIT MIT INNENGEWINDE
COUPLEUR DE SÉCURITÉ FÊMELLE
ENCHUFE DE SEGURIDAD HEMBRA
SOQUETE DE SEGURANÇA COM ROSCA FÊMEA

Code	A	B	C	D	CH	Pack.
OB162 00 001	1/4	9	71	26	21	10
OB162 00 002	3/8	12	74	26	21	10
OB162 00 003	1/2	15	78	26	24	10

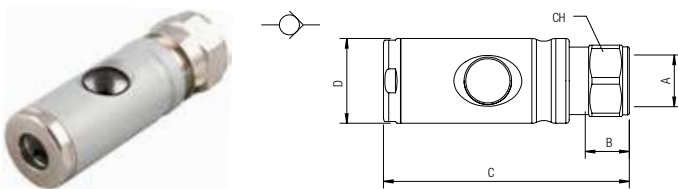

OB165

PRESA DI SICUREZZA PORTAGOMMA

SAFETY SOCKET FOR RUBBER HOSE
 STECKER SICHERHEIT FÜR GUMMISCHLAUCH
 COUPLEUR DE SECURITE POUR TUYAU
 ENCHUFE DE SEGURIDAD CON PORTAGOMA
 SOQUETE DE SEGURANÇA COM ESPIGÃO PARA TUBO DE BORRACHAT

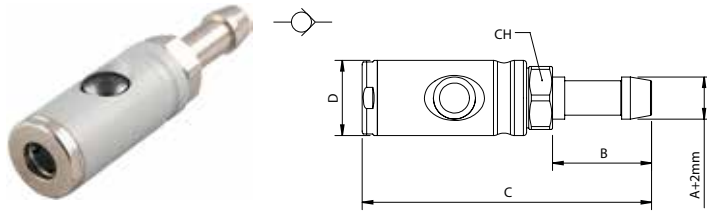

Code	A	B	C	D	CH	Pack.
OB165 00 001	6	27.5	92.5	26	21	10
OB165 00 002	8	27.5	92.5	26	21	10
OB165 00 003	10	27.5	92.5	26	21	10
OB165 00 004	12	33	98	26	21	10

261AC DN 7.8

INNESTO IN ACCIAIO MASCHIO

STEEL MALE PLUG
 STECKER MIT AUSSENGEWINDE AUS STAHL
 EMBOUT MÂLE EN ACIER
 ADAPTADOR EN ACERO MACHO
 PLUG EM AÇO COM ROSCA MACHO

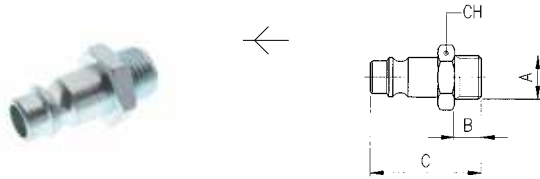

Code	A	B	C	CH	Pack.
261AC 00 51 03 ZI	1/4	8	33	17	10
261AC 00 51 04 ZI	3/8	9	34	19	10
261AC 00 51 05 ZI	1/2	10	35.5	24	10

Acciaio Indurito
 Hardened Steel
 Gehärtetem Stahl
 Acier Trempé
 Acero Curtido
 Aço Endurecido

262AC DN 7.8

INNESTO IN ACCIAIO FEMMINA

STEEL FEMALE PLUG
 STECKER MIT INNENGEWINDE AUS STAHL
 EMBOUT FEMELLE EN ACIER
 ADAPTADOR EN ACERO HEMBRA
 PLUG EM AÇO COM ROSCA FÊMEA

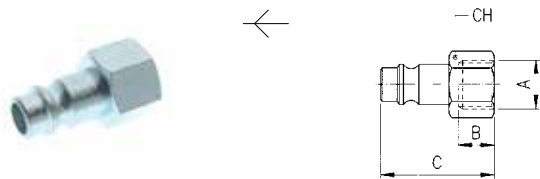

Code	A	B	C	CH	Pack.
262AC 00 51 03 ZI	1/4	11	33	17	10
262AC 00 51 04 ZI	3/8	11.5	33.5	19	10
262AC 00 51 05 ZI	1/2	14	36	24	10

Acciaio Indurito
 Hardened Steel
 Gehärtetem Stahl
 Acier Trempé
 Acero Curtido
 Aço Endurecido

265AC DN 7.8

INNESTO IN ACCIAIO CON PORTAGOMMA A RESCA

STEEL BARBED PLUG
 STECKER MIT SCHLAUCHTÜLLE AUS STAHL
 EMBOUT À DOUILLE ANNELÉE POUR TUBE EN ACIER
 ADAPTADOR EN ACERO ESPIGA
 PLUG EM AÇO COM ESPIGÃO PARA TUBO DE BORRACHA

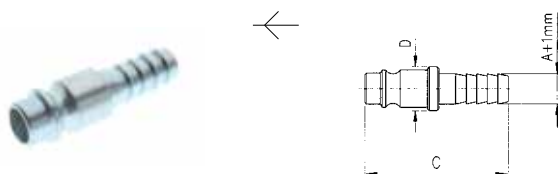

Code	A	C	D	Pack.
265AC 00 51 X4 ZI	6	39.5	12	10
265AC 00 51 X7 ZI	8	39.5	12	10
265AC 00 51 X9 ZI	10	42.5	14	10
265AC 00 51 Y1 ZI	12	42.5	16	10

Acciaio Indurito
 Hardened Steel
 Gehärtetem Stahl
 Acier Trempé
 Acero Curtido
 Aço Endurecido